

Installation, Operation and Maintenance Manual

4-Stage Reverse Osmosis Systems

Model PWRO4

PURE WATER



PWRO4

⚠ WARNING



Please read carefully before proceeding with installation. Your failure to follow any attached instructions or operating parameters may lead to the product's failure.



Keep this Manual for future reference.

⚠ WARNING

Do not use with water that is microbiologically unsafe or of unknown quality without adequate disinfection before or after the system.

IMPORTANT

If you are unsure about installing your WATTS water filter, contact a WATTS representative or consult a professional plumber.

⚠ CAUTION

Test the water periodically to verify that the system is performing satisfactorily. Discard small parts remaining after the installation.

NOTICE

Failure to install the system correctly voids the warranty.
Handle all components of the system with care. Do not drop, drag or turn components upside down.
Be sure the floor under the water filter system is clean, level and strong enough to support the unit.



System tested and certified by WQA against NSF/ANSI Standard 58 for the reduction of the claims specified on the performance data sheet and NSF/ANSI Standard 372 for lead free.

Table of Contents

Pages

Operational Parameters	3
Contents of Reverse Osmosis System	3
Tools Recommended For Installation	3
Drill a Hole for the Faucet in a Porcelain Sink	3
Punch a Hole for the Faucet in a Stainless Steel Sink	3
Watts Standard Faucet Installation	4
Adapt-A-Valve™ Installation	5
Drain Saddle Installation	5
Drill Hole and Connect 3/8" Black Tube from Faucet to the Drain Saddle	6
Green Tube Connection	6
Reverse Osmosis Module Mounting	6
Red 1/4" Tube Connection (from faucet)	6
Check Air Pressure in the Tank	6
Tank Ball Valve Installation	6
Blue Tube Connection (to RO tank)	7
Blue Tube Connection (from faucet)	7
Start Up Instructions	7
6-Month Maintenance	8
Annual Maintenance	8
Membrane Replacement	9
Procedure for Extended Non-Use (More than 2 months)	9
Troubleshooting	10
Parts List	11
Arsenic Facts	12
Service Record	13
Limited Warranty	16

WATTS®

Introduction

Thank you for your purchase of a state of the art Watts Pure Water Reverse Osmosis (RO) water treatment system. Water quality concerns are becoming more of a focus for the public. You may have heard about contaminants in the drinking water, such as Arsenic, Chromium, Cryptosporidium or Giardia. There may also be some local water issues such as high levels of Lead and Copper. This Watts Pure water treatment system has been designed and tested to provide you with high quality drinking water for years to come. The following is a brief overview of the system.

Your Reverse Osmosis System:

Osmosis is the process of water passing through a semi-permeable membrane in order to balance the concentration of contaminants on each side of the membrane. A semi-permeable membrane is a barrier that will pass some particles like clean drinking water, but not other particles like arsenic and lead.

Reverse osmosis uses a semi-permeable membrane; however, by applying pressure across the membrane, it concentrates contaminants (like a strainer) on one side of the membrane, producing crystal clear water on the other. This is why RO systems produce both clean drinking water and waste water that is flushed from the system. This reverse osmosis system also utilizes carbon block filtration technology and can, therefore, provide a higher quality drinking water than carbon filtration systems alone.

Your system is a 4-Stage RO which is based upon separate treatment segments within the one complete water filtration system. These stages are as follows:

Stage 1 – Sediment filter, recommended change 6 months.

(See Page 8).

The first stage of your RO system is a five-micron sediment filter that traps sediment and other particulate matter like dirt, silt and rust which affect the taste and appearance of your water.

Stage 2 – Carbon filter, recommended change 6 months.

(See Page 8).

The second stage contains a five-micron carbon block filter. This helps ensure that chlorine and other materials that cause bad taste and odor are greatly reduced.

Stage 3 - Membrane, recommended change 2-5 years.

Stage 3 is the heart of the reverse osmosis system, the RO membrane. This semi-permeable membrane will effectively take out TDS, sodium and heavy metals such as arsenic, copper, and lead, as well as Cysts, such as Giardia and cryptosporidium. Because the process of making this high quality drinking water takes time, your RO water treatment system is equipped with a storage tank.

Stage 4 - Carbon in-line filter, recommend change 6 - 12 months.

The final stage is an in-line granular activated carbon (GAC) filter. This filter is used after the water storage tank, and is used as a final polishing filter.

NOTICE

Filter & Membrane life may vary based upon local water conditions and/or use patterns.

Replacement Filter Packs

MODEL	FREQUENCY	DESCRIPTION
PWFPKSEDCB	6 Months	Includes sediment and carbon filter only
PWFPK4R04	Master Filter Kit	Includes all filters and membrane
PWMEM50	2 - 5 years	50 gpd membrane
PWILGAC10	Annual	10" final in-line filter

NOTICE

Water conditions may require more frequent cartridge replacement

System Maintenance

Just because you can not taste it, does not mean that it is not there. Contaminants such as lead, chromium and arsenic (to name a few) are undetectable to the taste. Additionally, over time if you do not replace the filter element, other bad tastes and odors will be apparent in your drinking water.

This is why it is important to change out your filter at the recommended intervals as indicated in this system manual. When replacing the filter elements, pay special attention to any cleaning instructions. Should you have any further questions please refer to our website at www.watts.com/purewater or call our customer service department at 1-800-244-1299.

With proper installation and maintenance, this system will provide you with high quality water for years to come. All of Watts water enhancement products are rigorously tested by independent laboratories for safety and reliability. If you have any questions or concerns, please contact our Customer Service department at 1-800-244-1299 or refer to our on-line troubleshooting at www.watts.com/purewater.

Operational Parameters

Operating Temperatures	Maximum 100°F (37.8°C)	Minimum 40°F (4.4°C)
Operating Pressure	Maximum 85psi (6.0 kg/cm ²)	Minimum 40psi (2.80 kg/cm ²)
pH Parameters	Maximum 11	Minimum 2
Iron	Maximum 0.2 ppm	
TDS (Total Dissolved Solids)	< 1800 ppm	
Turbidity	< 5NTU	

Hardness: Recommended hardness not to exceed 10 grains per gallon, or 170ppm. System will operate with hardness over 10 grains but the membrane life may be shortened. Addition of a water softener may lengthen the membrane life.

Water Pressure: The operating water pressure in your home should be tested over a 24-hour period to attain the maximum pressure. If the incoming water pressure is above 85psi, a pressure regulator is recommended and if over 100psi, then a pressure regulator is required.

Copper Tubing: Reverse Osmosis water should not be run through copper tubing as the purity of the water will leach copper causing an objectional taste in water and pin holes may form in the tubing. Watts supplies speciality filters that can be used if copper tubing follows the Reverse Osmosis unit. Be sure to follow any state or local regulations during installation.

Contents of Reverse Osmosis (RO) System

- 1 Tank – Blue or White
- 1 RO Module
- 1 Parts Bag – With a 10" Final Filter
- 1 Faucet Bag
- 1 Manual

If any of the items are missing please contact prior to installing.

Tools Recommended for Installation

- 1¼" Hole Saw Bit for Faucet opening
- Round Knockout Punch for Stainless Sinks 1¼"
- Adjustable Wrench
- Sharp Knife
- ½" & ⅝" Open End Wrenches
- Phillips Screw Driver
- Needle Nose Pliers – Adjustable Pliers
- Electric Drill
- ⅛" Drill Bit
- ¼" Drill Bit
- ⅜" Drill Bit



STEP 1

Drill a Hole for the Faucet in a Porcelain Sink

Most sinks are predrilled with 1½" or 1¼" diameter hole that you can use for your RO faucet. (If you are already using it for a sprayer or soap dispenser, see Step 2).

NOTICE

Porcelain sinks are extremely hard and can crack or chip easily.

Use extreme caution when drilling. Watts accepts no responsibility for damage resulting from the installation of faucet.

Step A – Determine desired location for the RO faucet on your sink and place a piece of masking tape on over where the hole is to be drilled. Mark the center of the hole on the tape.

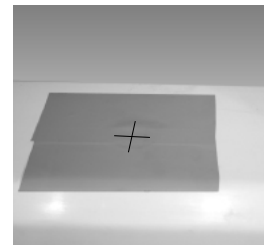

Step B – Using a variable speed drill set on the slowest speed, drill a ⅛" pilot hole through both porcelain and metal casing of sink at the marked center of the desired location. Use lubricating oil or liquid soap to keep the drill bit cool (If drill bit gets hot, it may cause the porcelain to crack or chip).



Step C – Using a 1¼" hole saw, proceed to drill the large hole. Keep drill speed on the slowest speed and use lubricating oil or liquid soap to keep the hole saw cool during cutting.

Step D – Make sure the surroundings of the sink are cooled before mounting the faucet to the sink after drilling and remove all sharp edges.

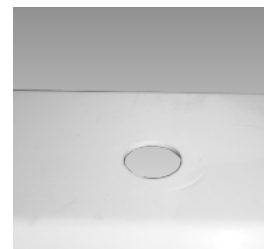

OR

Punch a Hole for the Faucet in a Stainless Steel Sink

If mounting faucet to a Stainless Steel Sink, you will need a 1¼" Hole Punch. The faucet opening should be centered between the back splash and the edge of the sink, ideally on the same side as the vertical drain pipe.



Step A – Drill a ¼" pilot hole. Use a ½" Hole Punch and an adjustable wrench to punch the hole in the sink. Change to the 1¼" Hole Punch to enlarge the hole



The faucet can now be installed.

STEP 2

Parts List

1. Faucet
2. Black Drain Tube (3/8" Black)
3. Red Tube 1/4"
4. Escutcheon Plate
5. Full Circle Rubber Gasket
6. Slotted Metal Washer
7. Plastic Sleeve
8. Plain Washer
9. Hex Nut Washer
10. Hex Nut
11. Plastic Tube Insert
12. White Plastic Delrin Sleeve
13. Water Connector Nut
14. Blue Tube 1/4"

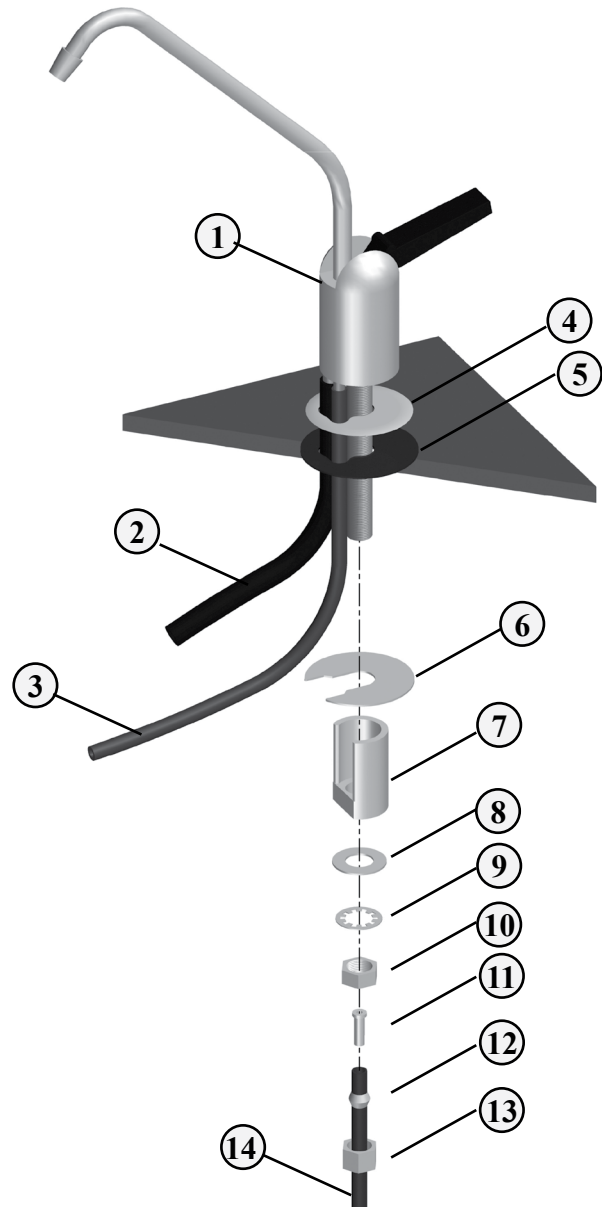

Step A – Remove nut (Item 13) and blue tubing (Item 14) from faucet. (Leave the nut and plastic delrin sleeve (Item 11 & 12) on the blue tube).

Step B – Feed both the red and black tubing through the pre-drilled hole in the sink/counter until faucet is seated.

Step C – Under the sink - on to the threaded faucet stem in order first slide on the slotted washer (Item 6), the white spacer with the open end UP (Item 7), the hex nut washer (Item 8), the slotted washer (Item 9) and lastly secure with nut (Item 10).

Step D – Make sure the plastic delrin sleeve (Item 12) is on the end of the blue tube; push the white plastic insert (Item 11) into the end of blue tubing with the delrin sleeve. Insert the blue tube (Item 14) into the faucet stem and secure with nut (Item 13).

NOTICE

DO NOT overtighten nut.

STEP 3

Adapt-A-Valve™ Installation

Verify contents prior to installation:

- (1) - Plastic Adapt-a-Valve™ & Black Collet
- (1) - Brass Adapter no washer
- (1) - Brass Adapter with black washer
- (1) - White rubber washer

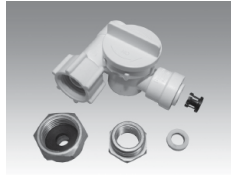

NOTICE

Water supply line to the system must be from the cold water supply line only. Hot water will severely damage your system.

NOTICE

Do not use Teflon tape with the Adapt-A-Valve™.

For 3/8" Configuration

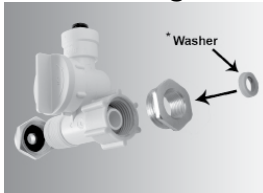

(With Brass Fittings)
* Insert White Washer



Hot Supply Cold Supply

For 1/2" Configuration



(Without Brass Fittings)
1/2" Configuration

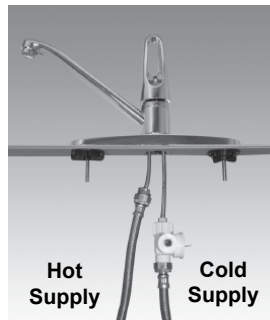

Hot Supply Cold Supply

Step A - Turn off the cold water supply to the faucet by turning the angle stop valve completely off.

Step B - Open cold water sink faucet to relieve pressure.

Step C - Choosing the configuration that fits your plumbing, attach the Adapt-A-Valve™ as illustrated in the four photos above.

STEP 4

Drain Saddle Installation - Fits standard 1 1/4" - 1 1/2" drain pipes

Follow all local plumbing codes for your installation.

NOTICE

If you have a garbage disposal, do not install the drain saddle near it. Installation of the drain saddle must be either above the garbage disposal, or if a second sink drain is available, install it above the cross bar on the second drain. Installation of the drain saddle near a garbage disposal may cause the drain line to plug.

Step A - Locate the drain saddle kit in the parts bag.

Gather the pieces of the drain saddle

- (1) - Black compression nut
- (1) - Semicircle bracket with opening
- (2) - Screws
- (1) - Foam gasket
- (2) - Nuts for screws
- (1) - Semicircle bracket

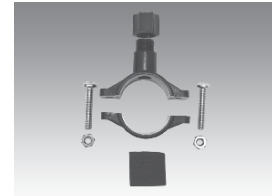

Step B - The small square black foam gasket with a circle cut out of the middle must be applied to the inside of the drain saddle. Remove sticky tape backing and stick to the drain saddle as shown.

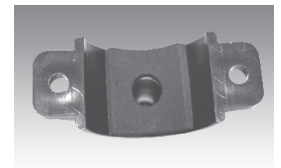
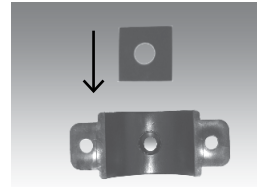

Step C - The drain saddle must be installed at least 1 1/2" above the nut of the P-Trap elbow or cross bar from the garbage disposal to insure proper drainage. Using the 1/4" drill bit, drill into the drain pipe at best available location as specified above, for drain saddle installation. Take extreme caution to only drill through one side of the drain pipe.

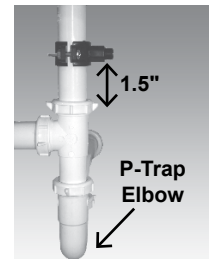

Step D - Assemble the drain saddle around the drain pipe and align drain saddle fitting opening with the hole drilled in the previous step - you may use a small screwdriver to feed through the drain saddle into the drain pipe to aid with the alignment. Using a Phillips screw driver tighten the drain saddle bolts evenly and securely on both sides.

NOTICE

Do not over tighten the screws. It may crack the drain saddle.

Drain Saddle Tube Connection

The black 3/8" drain tube must be as SHORT and STRAIGHT as possible to the drain saddle, making a downward slope from faucet to drain saddle to allow for proper drainage. This is a gravity fed line and if there is any bend or dip in the tube, the rinse water will not flow into the drain properly. Water may back up and come out the air gap hole in the back of the faucet.

Step A - Measure the 3/8" drain tube from faucet to the drain saddle on the drain pipe and make a straight cut to the correct length.

Step B - Slip drain tube through black compression nut. Insert drain tube into the opening in the drain saddle and hand tighten the black nut, and add 1/4 turn with a wrench.



STEP 5

Green Tube Connection

Step A – Locate green tube attached to the RO Module. Insert the open end of the green ¼" tube into the open ¼" Quick-Connect fitting on the Adapt-A-Valve™ making sure the tube is pushed in all the way to the tube stop.



Step B – Connect the green tube from the RO module to the Adapt-A-Valve™ that is connected to the angle stop valve. Leave enough tube so it is not kinked and cut the tube to the desired length.

STEP 6

Reverse Osmosis Module Mounting

Step A – Determine best location for the RO module to be mounted to allow for future system maintenance. The parts bag has 2 self-tapping screws. Using an electric drill with a Phillips bit, screw them into the cabinet wall 6" apart and 16" from the bottom of the cabinet.

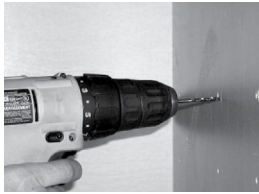

Do not cut any RO system tubes at this time

STEP 7

Red ¼" Tube Connection (from faucet)

Step A – Using the white plastic union found in the parts bag, determine where the ¼" red tubing from the faucet and the ¼" red tubing from the RO membrane housing would join together comfortably. Cut red tube from RO faucet to length leaving a straight cut edge. Insert the red tube from RO faucet in one end of the white plastic union and the red tube from RO membrane housing in the other end. Use a ⅝" wrench to tighten both of the white plastic nuts securely.



STEP 8

Check Air Pressure in the Tank

Check air pressure when tank is empty of water!

Check air pressure in the storage tank when you notice a decrease in available water from the RO system. Air can be added with a bicycle pump using the schrader valve that is located on the lower side of the tank behind the blue plastic cap.

Step A – Turn off the incoming water supply to the RO by turning the knob on the Adapt-A-Valve™ clockwise until it stops. (Follow the green tube away from the RO system to find the Adapt-A-Valve™.)



Step B – Open the RO Faucet and allow water to drain from the tank until it is completely empty.

When water from the RO faucet slows to a trickle with the faucet still in the open position, you may add air to the tank to purge any left over water. This will ensure that the tank is completely empty.

Step C – Once all water in the tank is purged, check air pressure using an air pressure gauge. It should read between 5 - 7psi. (Digital air pressure gauge is recommended)

Step D – Follow startup procedure on Page 7.

STEP 9

Tank Ball Valve Installation

Step A – Wrap (7 to 12 turns) of Teflon® tape clockwise around the male pipe threads (MPT) on the Stainless Steel fitting on top of the tank.

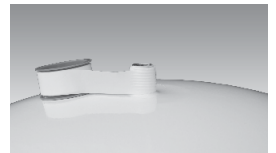

Do not let the tape cover the opening.

Step B – Thread the plastic elbow ball-valve (supplied in the parts bag) onto the stainless steel connection on the top of tank. Tighten using an adjustable wrench. Do not over tighten as plastic could crack.

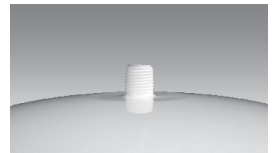

Teflon® is a registered trademark of E.I. DuPont de Nemours & Company.

STEP 10

Blue Tube Connection (to RO tank)

Step A– Position the RO storage tank in a desired location. You may stand it upright or lay it on its side (using the black plastic stand included).

Step B– Locate the 1/4" blue tube in the parts bag. Connect one end of the tube to the **tee** fitting attached to the inline polishing filter, clipped on to the RO membrane housing. Insert the tube into the open tee fitting and use a 5/8" wrench to tighten the white plastic nut securely.

Step C– Measure the tube from the inline polishing filter the tank and cut it to length leaving a straight, square edge. To connect the blue tube to the ball valve fitting, slip the blue tube through the white compression nut, hand tighten the white nut and add 1/4 turn with a 5/8" wrench.

Set the blue ball valve knob in-line with the blue tube, this is the "open" position.

STEP 11

Blue Tube Connection (from faucet)

Step A– Locate the 1/4" blue tube attached to the RO faucet. Connect the open end of the tube to the **straight** fitting attached to the inline polishing filter clipped on to the RO membrane housing. Insert the tube into the open fitting and use a 5/8" wrench to tighten the white plastic nut securely.

Startup Instructions

Step A– Turn on the incoming cold water at the angle stop valve. Turn the knob on the Adapt-A-Valve™ by turning counterclockwise. Check the system for leaks, and tighten any fittings as necessary. (Check frequently over the next 24 hours to ensure no leaks are present).

If you have connected your RO system to a refrigerator / ice maker, make sure the ice maker is off (do not allow water to flow to the ice maker) until flushing is complete and the tank has been allowed to fill completely. Connection from the RO to the ice maker system should have an inline valve installed before the ice maker so it can easily be closed to prevent water flowing to the ice maker during startup and periodic maintenance. Your RO tank must be allowed to fill up fully in order for the ice maker system to work properly.

Step B – Open the RO faucet and leave it open until water begins to trickle out. (It will come out slowly).

Step C – After water trickles out of the faucet, close the RO faucet allowing the storage tank to fill with water. It may take 4 to 6 hours to fill the tank completely depending on the production capability of the membrane, local water temperature and water pressure.

During the fill period, you may hear water trickling due to the Reverse Osmosis Process.

Step D – After the Tank has filled, open the RO Faucet to flush the tank completely to remove carbon particles from final filter. You will know that the tank is empty when the flow rate from the RO faucet is down to a trickle. Repeat this step two more times. The fourth tank can be used for drinking.

NOTICE

Flushing of the tank three times is only necessary during the initial startup and after replacing the membrane.

NOTICE

Your reverse osmosis system contains replaceable treatment components that are critical for effective containment reduction. Periodic inspection and following proper system maintenance is critical for continued performance.

6-Month System Maintenance

Order filter by calling Watts at 1-800-224-1299

Item Needed: EDP# 7100110

Includes:

- (1) Sediment Filter
- (1) Carbon Block Filter

Step A – Turn off the incoming water supply to the RO by turning the knob on the Adapt-A-Valve™ clockwise until it stops.

Step B – Open the RO Faucet and allow water to drain from the tank until it is completely empty.

Water may be saved in a container for drinking or to rinse system parts.

Step C – Let system sit for 10 to 15 minutes after the tank is empty to let the system depressurize before attempting to remove filter housings.

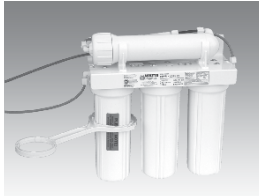

Step D – For more leverage you may leave the RO module attached to wall of cabinet. If you are unable to access the module while it is mounted, remove it prior to changing filters. Starting with the closest housing (Stage 1), remove it by turning it clockwise (left), empty water, then discard filter. Continue on to the 2nd housing (Stage 2) and 3rd housing (Stage 3).

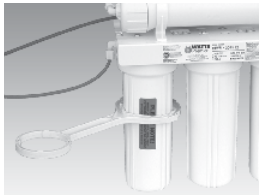

If you own a 4-stage system it will not have the third stage. A 4-stage system has two vertical housings instead of three.

Step E – Clean the filter housings (bowls) with a mild soap solution and rinse with water. Check O-rings and lubricate with water soluble lubricant. KY Jelly®, canola oil or other water based lubricants may be used. **Petroleum based lubricants (such as Vaseline®) must not be used.**

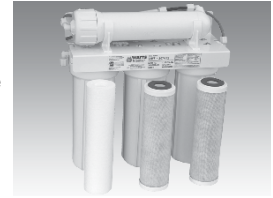

NOTICE

Before re-installing the filter bowls back on to the system, check O-rings to make sure they are still in place.

Do not over-tighten filter housing, overtightening may damage O-ring(s), cause water leaks, or affect system performance.



Step F – Insert a new sediment filter (cloth like appearance) into the 1st filter housing which is the one on the water inlet side (green tubing from the Adapt-A-Valve™) of the RO system, and re-install housing.

Step G – Insert the new Carbon Block filter (White end caps & plastic netting) into the second and third filter bowls and re-install housings.

Step H – Turn water supply on to the unit by turning the knob on the Adapt-A-Valve™ counterclockwise.

Step I – Open the RO faucet and leave it open until water begins to trickle out. (It will come out slowly).

Step J – Close the RO faucet allowing the storage tank to fill with water. It may take 4 to 6 hours to fill the tank completely

Step E – Turn off the incoming water supply to the system by turning the Adapt-A-Valve™ clockwise until it stops. Keep the RO faucet open until the storage tank is completely drained.

Step F – Open the membrane housing and re-install the RO membrane while making sure not to kink the O-rings. (Refer to “Membrane Replacement” section on Page 9 for directions on installing the membrane). Tighten the cap back on the housing and reconnect green tubing.

Step G – Remove filter housings Stage 1 and 2 and empty of water.

NOTICE

Before re-installing the filter bowls back on to the system , check O-rings to make sure they are still in place and lubricate with water soluble lubricant.

Do not over-tighten filter housing, overtightening may damage O-ring(s), cause water leaks, or affect system performance.

Step H – Insert the new Sediment Filter (cloth like appearance) into the 1st filter housing which is the one on the water inlet side (green tubing from the Adapt-A-Valve™) of the RO system and re-install housing.

Step I – Insert the new Carbon Block filter (White End Caps) into the 2nd housing and re-install housing.

Step J – The Final filter is clipped on to the membrane housing. Remove it by first loosening the compression fittings on both ends of the filter and disconnecting the blue tubing. Remove filter from holding clips and replace with new filter. (Discard used final filter after sanitizing) Re-attach tubing.

The arrow on the final filter must be pointing towards the RO faucet / away from the RO storage tank.

This is a good time to check the air pressure in your storage tank. For instructions please see Page 9.

Step K – Follow Steps H through J in the 6-Month System Maintenance (Page 7) for startup directions.

Annual Maintenance

Order filter by calling Watts at 1-800-224-1299

Item Needed: # 7100110, 7100454

1/2 cup of hydrogen peroxide or household bleach.

Includes:

- (1) Sediment Filter
- (1) Carbon Block Filter
- (1) Final In-Line Filter

Sanitizing of unit is recommended.

Step A – Perform steps A through E in the Six Month System Maintenance.

If not sanitizing the system skip to step H.

Step B – Remove the RO membrane from its housing and rest in a clean sanitary place. (Refer to “Membrane Replacement” section on Page 9 for directions on removing the membrane). Replace cap onto empty membrane housing and re-connect green tubing.

Step C – Leaving the filters out, replace Stage 1 and 2 empty filter housings (hand tight) onto unit. Measure & pour either ½ cup of hydrogen peroxide or common household bleach into the 1st filter housing (Stage 1) and hand tighten onto unit.

NOTICE

Overtightening components can damage the system causing water damage and/or system failure.

Step D – With the RO faucet in the closed position turn on the incoming water supply to the system by turning the Adapt-A-Valve™ counterclockwise. Wait 1 minute for the unit to pressurize. Turn on the RO faucet, and let the water run for 30 seconds. Turn off the RO faucet, and let the unit rest for 2 minutes. Finally, open the RO faucet, and let the water run for 5 more minutes.

Membrane Replacement

Order membrane by calling Watts at 1-800-224-1299

Item Needed: # 7100122,

Includes:

- (1) RO Membrane

This reverse osmosis system contains a replaceable component (the RO membrane) which is critical to the efficiency of the system.

Replacement of this reverse osmosis membrane should be with one of identical specifications as defined by Watts to assure the same efficiency and contaminant reduction performance.

Membranes have a life expectancy between 2 and 5 years, depending on the incoming water conditions and the amount the RO system is used. This reverse osmosis membrane is critical for effective reduction of total dissolved solids (TDS). The product water should be tested periodically to verify that the system is performing satisfactorily.

Normally, a membrane would be replaced during a semiannual or annual filter change. However, if at any time, you notice a reduction in water production or an unpleasant taste in the reverse osmosis water, it could be time to replace the membrane. Watts recommends replacing the membrane when TDS reduction falls below 75%.

A water sample may be sent to Watts for a free diagnosis of your membrane performance. To send a water sample, use two (2) clean containers and fill ½ cup of tap water in one container and ½ cup of reverse osmosis water in 2nd container. Clearly label each sample. Send the samples to the address listed on the cover of this manual attention "Water Samples". Watts will test the water and mail or call you with the results.

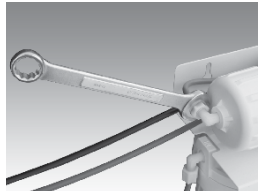

Step A – Turn off the incoming water supply to the RO by turning the knob on the Adapt-A-Valve™ clockwise until it stops.

Step B – Open the RO Faucet and allow water to drain from the tank until it is completely empty.

Removing the Membrane

Step A – Use a 5/8" wrench to remove the Green Tube fitting on the left side of the horizontal membrane housing (end with one elbow).

Step B – Remove the cap from the membrane housing by turning it counterclockwise to loosen.

A double sided wrench may be purchased from Watts to aid with loosening the cap / filter housings.

Step C – Remove membrane housing from the holding clips. Using a pair of pliers, grip the PVC tube of the RO membrane and pull firmly on the membrane to remove from the housing and discard.

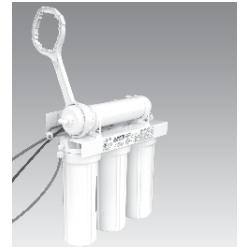

Installing the Membrane

Step A – Lubricate the O-rings on the new membrane with a water soluble lubricant such as KY Jelly ®. Insert the end with the two black O-rings first into the housing.

Step B – Once membrane has been inserted into the housing you must take your thumbs and give a firm push to properly seat the membrane. Replace membrane housing cap and tighten.

Step C – After replacing membrane housing into clips, attach the green tube to the elbow on cap using 5/8" wrench.

Step D – Follow the Start Up Instructions on Page 7.

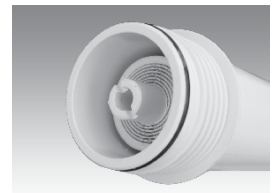
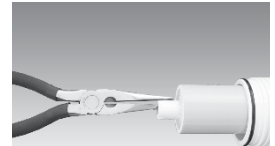

Procedure for Extended Non-Use

(More than 2 months)

Turn off the water supply by turning the knob on the Adapt-A-Valve™ clockwise until it stops, and open the RO faucet to empty the storage tank. (Save a few ounces of RO water). Once the storage tank is empty, remove the membrane, and place it in a sealed plastic bag with the RO water saved earlier and store in your refrigerator.

For restart, reinstall membrane (See Page 9 for membrane installation procedure) and follow startup procedure on Page 7.

Troubleshooting

PROBLEM	CAUSE	SOLUTION
1. Low/Slow production	Low water pressure	Assure a minimum of 40psi incoming water pressure. Watts sells a booster pump if home water pressure is low. Make sure water supply is turned on and Adapt-A-Valve™ is all the way open.
	Crimps in tubing	Check tubing and straighten or replace as necessary.
	Clogged pre-filters	Replace pre-filters.
	Fouled membrane	Replace membrane and flow restrictor.
2. Milky colored water	Air in system	Air in the system is a normal occurrence with initial start up of the RO system. This milky look will disappear during normal use within 1-2 weeks. If condition reoccurs after filter change, drain tank 1 to 2 times.
3. Water constantly running, unit will not shut off	Low water pressure	See #1 above
	Crimp in supply tube	Check tubing and straighten or repair as necessary.
	High water pressure	Check incoming water pressure to make sure it does not exceed 80psi. A pressure relief valve may be necessary.
	High pressure in Tank	Empty storage tank of water. Set tank air pressure between 5-7psi. See previous page.
	Low Pressure in Tank	Use a Digital Air Gauge for best results. The empty tank pressure should be 5-7psi. See Page 9.
4. Noise / Water from faucet vent hole or noise from in drain line drain.	Crimp or restriction	Check tubing and straighten or repair as necessary. Straighten all drain lines. Clear blockage. Cut off any excess tubing
	Drain tube clogged	Caused from dishwasher or garbage disposal. Disconnect the 3/8" black line at the drain, clean the 3/8" black line out with a wire, then reconnect. Blowing air through the line will not always remove the clog.
5. Small amount of water in storage tank	System starting up	Normally it takes 4-6 hours to fill tank. Note: low incoming water pressure and/or temperature can drastically reduce production rate.
	Low water pressure	See #1 above.
	To much air in tank	Tank air pressure should be 5-7psi when empty of water. If below 5psi, add air or bleed if above 7psi. Check only when tank is empty of water. See previous page.
6. Water leaks from the blue or white filter housing	Not properly tightened	Tighten the bowl.
	Kinked O-ring	Turn off the water supply and release the pressure. Replace the O-ring if necessary. Then lubricate it and make sure the O-ring is seated in the filter bowl properly before reinstalling the filter bowl.
7. Low water flow from faucet		Check air pressure in tank Use a Digital Air Gauge for best results. The empty tank pressure should be 5-7psi. See Page 9.

Parts List

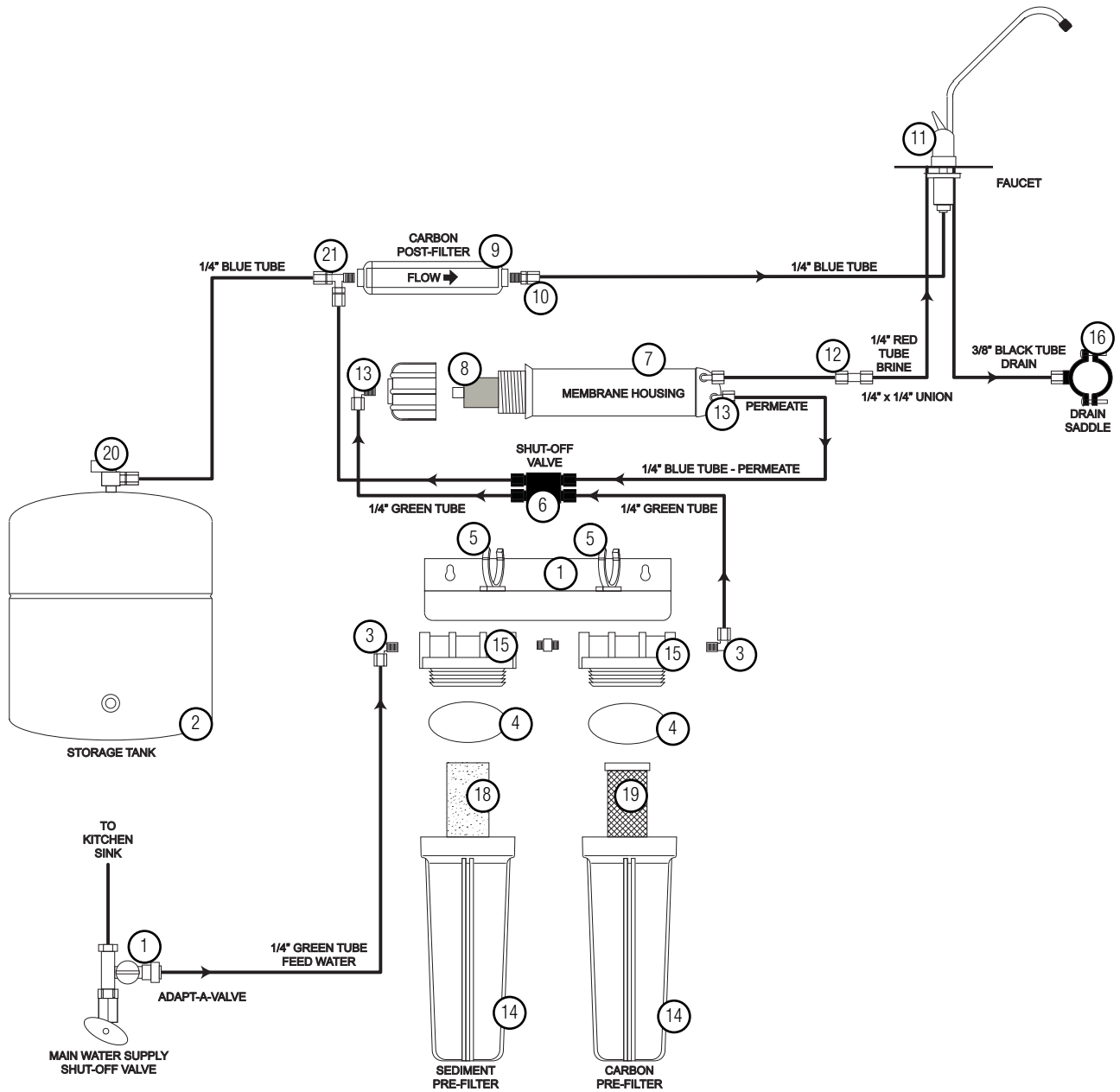

ITEM #	EDP #	DESCRIPTION
1	7300068	ADAPT-A-VALVE™
2	7100174	STORAGE TANK-3 GAL WHITE
3	7300031	ELBOW - 1/4" C x 1/4" M
4	7300060	O-RING FOR FILTER HOUSING
5	7300049	MOUNTING CLIP - MEMBRANE HOUSING
6	7300070	AUTOMATIC SHUT-OFF-VALVE - 1/4" QC
7	7300042	MEMBRANE HOUSING
8	7100122	REVERSE OSMOSIS MEMBRANE
9	7100454	GAC INLINE FILTER - 10"
10	7300091	PLASTIC CONNECTOR-1/4"Cx1/4"M
11	7100195	AIRGAP FAUCET-CHROME

ITEM #	EDP #	DESCRIPTION
12	7300090	1/4" X 1/4" UNION
13	7300032	ELBOW - 1/4 C X 1/8 M
14	7300044	FILTER HOUSING - BOWL - 10" - WHITE
15	7300081	FILTER HOUSING - LID - 1/4" PORTS
16	7300030	DRAIN SADDLE-3/8"
17	7300022	FLOW RESTRICTOR (NOT SHOWN)
18	7100331	SEDIMENT FILTER
19	7100446	CARBON BLOCK FILTER
20	7300615	TANK BALL VALVE
21	7300038	TEE 1/4 C X 1/4 C X 1/4M

Arsenic Facts

Arsenic (As) is a naturally occurring contaminant found in many ground waters. Arsenic in water has no color, taste or odor. It must be measured by an arsenic test kit or lab test.

Public water utilities must have their water tested for arsenic. You can obtain the results from your water utility contained within your consumer confidence report. If you have your own well, you will need to have the water evaluated. The local health department or the state environmental health agency can provide a list of test kits or certified labs.

There are two forms of arsenic: pentavalent arsenic (also called As (V), As (+5)) and trivalent arsenic (also called As (III), As (+3)). In well water, arsenic may be pentavalent, trivalent, or a combination of both. Although both forms of arsenic are potentially hazardous to your health, trivalent arsenic is considered more harmful than pentavalent arsenic.

RO systems are very effective at removing pentavalent arsenic. A free chlorine residual will rapidly convert trivalent arsenic to pentavalent arsenic. Other water treatment chemicals such as ozone and potassium permanganate will also change trivalent arsenic to pentavalent arsenic. A combined chlorine residual (also called chloramine) where it does convert trivalent arsenic to pentavalent arsenic, may not convert all the trivalent arsenic in to pentavalent arsenic. If you get your water from a public water utility, contact the utility to find out if free chlorine or combined chlorine is used in the water system.

This Watts reverse osmosis system is designed to remove up to 98% of pentavalent arsenic. It will not convert trivalent arsenic to pentavalent arsenic. Under laboratory standard testing conditions, this system reduced 0.30 mg/L (ppm) pentavalent arsenic to under 0.010 mg/L (ppm). (The USEPA standard for drinking water). Actual performance of the system may vary depending on specific water quality conditions at the consumer's installation. In addition to the independent laboratory standard testing conditions, Watts has conducted additional field testing on our reverse osmosis units to determine trivalent arsenic reduction capabilities. Based upon Watts field testing, it has been determined that the RO units are capable of reducing up to 67% of trivalent arsenic from the drinking water.

The RO membrane component of this Watts reverse osmosis system must be maintained according to its recommended maintenance cycle. Specific component identification and ordering information can be found in the installation/operation manual maintenance section, by phone at 1-800-224-1299 or online www.watts.com/purewater.

Performance Data Sheet

PWRO4

Watts Pure Water

8716 W Ludlow Drive Suite #1

Peoria, AZ 85381

1-(800)-224-1299

GENERAL USE CONDITIONS:

1. System to be used with municipal or well water sources treated and tested on regular basis to insure bacteriological safe quality. DO NOT use with water that is micro biologically unsafe or unknown quality without adequate disinfection before and after the system. Systems certified for cyst reduction may be used on disinfected water that may contain filterable cysts.
2. Operating Temperature: Maximum: 100°F (37.8°C) Minimum: 40° (4.4°)
3. Operating Water Pressure: Maximum: 100 psi (7.0kg/cm2) Minimum: 40 psi (2.8kg/cm2)
4. pH 2 to 11
5. Maximum iron present in incoming feed water supply must be less than 0.2 ppm.
6. Hardness of more than 10 grains per gallon (170 ppm) may reduce membrane life expectancy.
7. Recommend TDS (Total Dissolved Solids) not to exceed 1800 ppm.



RECOMMENDED REPLACEMENT PARTS AND CHANGE INTERVALS:

Note: Depending on incoming feed water conditions replacement time frame may vary.

Description	Change time Frame
Sediment Pre-filter: #7100331	6 Months
Carbon Pre-filter: #7100446	6 Months
Final Carbon filter #7100454	12 Months
R.O. Membrane: #7100122	2 to 5 years

This system has been tested according to NSF/ANSI 58 for reduction of the substances listed below. The concentration of the indicated substances in water entering the system was reduced to a concentration less than or equal to the permissible limit for water leaving the system as specified in NSF/ANSI 58. This system has been tested for the treatment of water containing pentavalent arsenic (also known as As (V), As (+5), or arsenate) at concentrations of 0.30 mg/L or less. This system reduces pentavalent arsenic, but may not remove other forms of arsenic. This system is to be used on water supplies containing a detectable free chlorine residual at the system inlet or on water supplies that have been demonstrated to contain only pentavalent arsenic. Treatment with chloramine (combined chlorine) is not sufficient to ensure complete conversion of trivalent arsenic to pentavalent arsenic. Please see the Arsenic Facts section of the Performance Data Sheet for further information.

	Avg. In. (mg/L)	Avg. Eff. (mg/L)	% Reduction	pH	Pressure	Max Eff. mg/L	Inf. challenge concentration mg/L	Max Allowable concentration mg/L
Cysts	222,077#/ml	10 #/ml	99.99%			58	minimum 50,000/mL	N/A
Nitrate	26.0 mg/L	6.1 mg/L	76.5%		50 psi	10 mg/L	27±10%	10.0
Nitrite	2.8 mg/L	0.5 mg/L	82%		50 psi	0.77mg/L	3.0±10%	1.0
TDS	765	24	96.8%	7.84			750±40mg/L	187

Recovery - 18.0%

Daily Production Rate - 11.0 GPD

Efficiency - 10.4%

	Avg. In. (mg/L)	Avg. Eff. (mg/L)	% Reduction	pH	Pressure	Max Eff. mg/L	Inf. challenge concentration mg/L	Max Allowable concentration mg/L
Arsenic (Pentavalent)	334.62 ug/L	5.039 ug/L	98.4%		50psi	19 ug/L	0.30±10%	0.010 mg/L
Barium Reduction	10.2	0.13	98.7%	7.24	50psi	0.27	10.0±10%	2.0
Cadmium Reduction	0.031	0.0001	99.7%	7.49	50psi	0.0009	0.03±10%	0005
Chromium (Hexavalent)	0.30	0.006	98.0%	7.24	50psi	0.013	0.03±10%	0.1
Chromium (Trivalent)	0.30	0.003	99.0%	7.24	50psi	0.008	0.03±10%	0.1
Copper Reduction	3.0	0.04	98.7%	7.64	50psi	0.06	3.0±10%	1.3
Fluoride Reduction	8.0	0.33	95.9%	7.49	50psi	0.47	8.0±10%	1.5
Lead Reduction	0.15	0.004	97.3%	7.49	50psi	0.008	0.15±10%	0.0107
Radium 226/228	25pCi/L	5pCi/L	80.0%	7.24	50psi	5pCi/L	25pCiL±10%	5pCiL
Selenium	0.10	<0.001	99.0%		50psi	<0.001	0.10±10%	0.05
Turbidity	81 NTU	0.15 NTU	99.8%		50psi	0.28 NTU	11±1 NTU	0.5 NTU

Depending on water chemistry, water temperature, and water pressure, R.O. Systems production and performance will vary.

Efficiency rating means the percentage of the influent water to the system that is available to the user as reverse osmosis treated water under operating conditions that approximate typical daily usage. Recovery rating means the percentage of the influent water to the membrane portion of the system that is available to the user as reverse osmosis treated water when the system is operated without a storage tank or when the storage tank is bypassed. There is an average of 4 gallons of reject water for every 1 gallon of product water produced.

REFER TO OWNER'S INSTALLATION/SERVICE MANUAL FOR FURTHER MAINTENANCE REQUIREMENTS AND WARRANTY INFORMATION.

WARNING: This product contains chemicals known to the State of California to cause cancer and birth defects or other reproductive harm.
For more information: www.watts.com/prop65

LIMITED WARRANTY: Certain Watts Pure Water products come with a limited warranty from Watts Regulator Co. Other products may have no warranty or are covered by the original manufacturer's warranty only. For specific product warranty information, please visit www.watts.com or the published literature that comes with your product. Any remedies stated in such warranties are exclusive and are the only remedies for breach of warranty. **EXCEPT FOR THE APPLICABLE PRODUCT WARRANTY, IF ANY, WATTS MAKES NO OTHER WARRANTIES, EXPRESS OR IMPLIED. TO THE FULLEST EXTENT PERMITTED BY APPLICABLE LAW, WATTS HEREBY SPECIFICALLY DISCLAIMS ALL OTHER WARRANTIES, EXPRESS OR IMPLIED, INCLUDING BUT NOT LIMITED TO THE IMPLIED WARRANTIES OF MERCHANTABILITY AND FITNESS FOR A PARTICULAR PURPOSE, AND IN NO EVENT SHALL WATTS BE LIABLE, IN CONTRACT, TORT, STRICT LIABILITY OR UNDER ANY OTHER LEGAL THEORY, FOR INCIDENTAL, INDIRECT, SPECIAL OR CONSEQUENTIAL DAMAGES, INCLUDING, WITHOUT LIMITATION, LOST PROFITS OR PROPERTY DAMAGE, REGARDLESS OF WHETHER IT WAS INFORMED ABOUT THE POSSIBILITY OF SUCH DAMAGES.**



A Watts Water Technologies Company

USA: Tel: (800) 224-1299 • Fax: (978) 794-1848 • Watts.com/PureWater

Canada: Tel: (905) 332-4090 • Fax: (905) 332-7068 • Watts.ca/PureWater

Latin America: Tel: (52) 81-1001-8600 • Fax: (52) 81-8000-7091 • Watts.com/PureWater