

Instructions for Installing PM-2C Snow & Ice Sensor Control

These instructions are intended to provide specific application information for installing the PM-2C snow and ice sensor control with the ProMelt snow melt products.

Please refer to the full instruction manual given with the product for further installation, Caution, and operation instruction. The PM-2C is a multi-voltage, self contained temperature, snow and ice sensor control. Each PM-2C can be set to operate with either 120, 208, 240 or 277 VAC and can control up to 30 amps of service to the load. The integrated snow sensor is heated to allow for snow, ice, or freezing rain to melt, allowing proper detection of environmental conditions.

WARNING



Read this Manual BEFORE using this equipment.

Failure to read and follow all safety and use information can result in death, serious personal injury, property damage, or damage to the equipment.

Keep this Manual for future reference.

WARNING

1. THIS UNIT SHOULD BE INSTALLED ONLY BY QUALIFIED PERSONNEL!
2. To prevent the risk of electric shock, disconnect all power from the control and associated equipment before opening the front cover plate.
3. Do not drill holes through the electrical enclosure for mounting. Mount the control to a free-standing conduit or via the pre-determined mounting holes.
4. Ensure front cover gasket is properly installed when replacing cover.

Installation

The PM-2C must be installed in a location that exposes the moisture grid to a clear view of the sky and any precipitation. The unit should not be mounted directly under eaves, overhangs, or other obstructions that can block precipitation from reaching the moisture grid.

Do not install the sensor close to the ground, or any other location, that can cause the sensor to be buried in snow.

Mount the PM-2C outdoors, away from furnace vents, dryer vents, and other sources of heat. The PM-2C can be mounted to a free-standing conduit or by using the mounting holes in each corner of the enclosure.

Do not drill holes in the enclosure.

Wire the controller in accordance to the provided schematics.

Setting Configuration

Before turning power on to the PM-2C sensor, it is important to set all control modes and settings.

1. Place the control in Standby/Reset with the switch mounted on the side before making configuration switch changes. Remember to return it to Automatic mode when finished.
2. Set the Trigger Temperature by adjusting the TRIG TEMP control for desired melting conditions. Precipitation below this temperature is assumed to be snow, above this is rain. Control comes with the TRIG TEMP dial set to 39°F (4°C).
3. Set the DELAY OFF time for 30 to 90 minutes (LD Off) or 2 to 6 hours (LD On). The Delay function will allow the snow melt system to run for the set time frame after moisture is no longer detected (once snowfall has stopped). This is to help prevent "black ice" from forming.

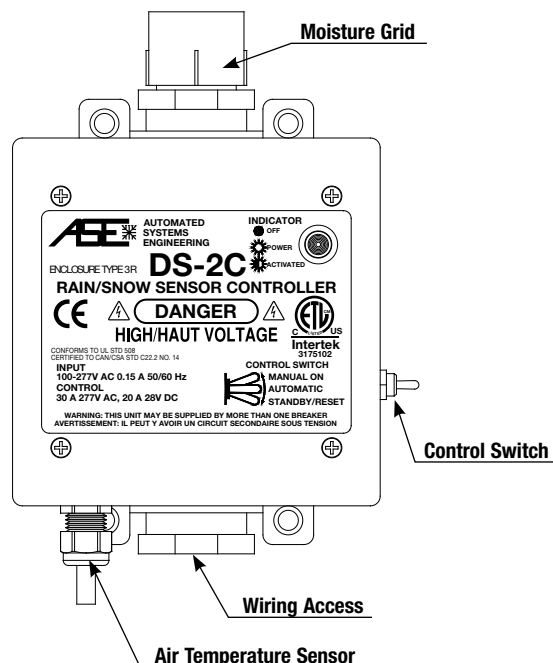
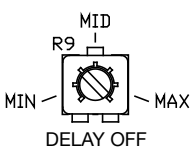
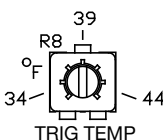

PM-2C provides integrated air and moisture detection within a rainproof and ice-resistant enclosure.

4. Determine how the sensor operates by setting the toggles located at S1.

Snow: The control will operate when precipitation is detected below the Temp Adjust setting. **Recommended ON.**

Rain: The control will operate when precipitation is detected above the Temp Adjust setting. **Required OFF.**

DEL: The control will operate with a Delay Off time. If this function is set to Off, the control will operate with a 2 minute delay to prevent short-cycling of external components. **Recommended ON.**

LTC: The control will operate in Low Temperature Cutoff mode, preventing operation when Ambient Temperatures (AT) fall below 5°F (-15°C). **Recommended ON (for systems with limited heat output).**

LD: This Long Delay switch determines the time span of the Delay Off drying cycle. Either 30-90 minutes (LD Off) or 2-6 hours (LD On). **Recommended OFF.**

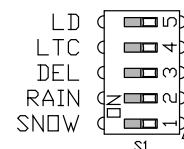

5. Set the precipitation SENSITIVITY to reduce nuisance triggering. MORE to trigger immediately upon detection. LESS to trigger with up to 120 seconds of detection. Recommended MORE to begin, then adjust as needed.

Power must be cycled for switch changes to take effect.

Manual Override Switch

An override switch is mounted on the side for testing and special operational requirements. Placing the switch in the "Automatic" position will allow the sensor to operate normally. "Manual On" will activate the control and will stay activated for a maximum of 40 hours before returning to "Automatic" mode. The "Stand-by/Reset" position will clear any current snow melt call or delay activity.

If the Manual Override Switch is moved to Manual On for less than 2 seconds and then back to Automatic the sensor will execute one Delay-Off cycle. This can be used to clear frost, hail, drifting snow, or other conditions. Stand-by/Reset will clear this setting.

ProMelt Display Panel

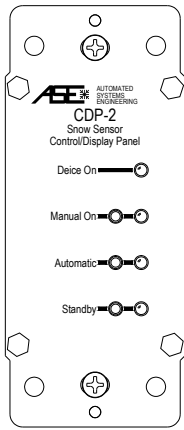

Indoor monitoring and control of the PM 2C is available with the optional PM DP snow melt sensor remote control. For more information see the PM DP submittal or installation instructions.

PM-2C Control

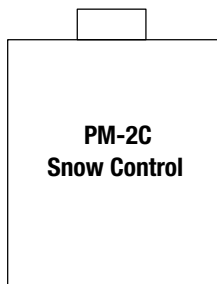
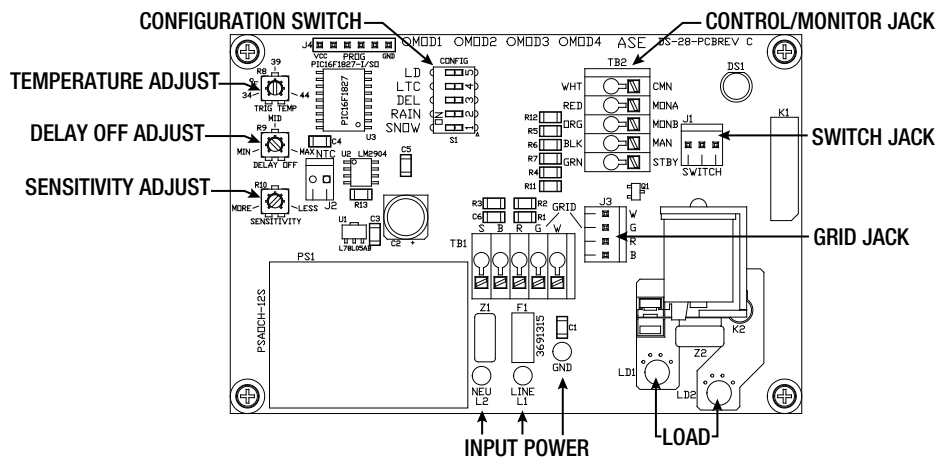

Circuit Breaker Panel

Ground Fault type breaker

120 / 208 /
240 / 277 VAC

Ground
L2 / N
L1

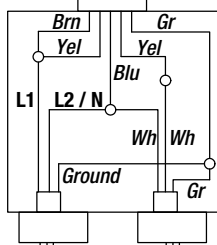

Waterproof
Junction Box

ProMelt
Mat/Cable

Specifications

Supply Voltage	100 - 277 VAC
Trigger Temperature Range (TT)	34°F to 44°F (1°C to 6.5°C)
Configuration Modes	Snow Only Rain Only Snow or Rain
Delay Settings (post melting)	30 to 90 minutes 2 to 6 hours
Low Temperature Cutoff (LTC)	Prevents system operation when Ambient Temperature (AT) is below 5°F (-15°C)
Operation Modes	Automatic Standby/Reset Manual

Recommended Switch Settings

Function	Trigger	LTC	DEL	RAIN	SNOW	LD Off	LD On
Snow sensor w/o LTC	TT>AT	OFF	OFF	OFF	ON	2 Min	2 Min
Snow sensor w/LTC	TT>AT>15°F (9.5°C)	ON	OFF	OFF	ON	2 Min	2 Min
Snow controller w/o LTC	TT>AT	OFF	ON	OFF	ON	30-90 Min	2-6 Hr
Snow controller w/LTC	TT>AT>15°F (9.5°C)	ON	ON	OFF	ON	30-90 Min	2-6 Hr

Do Not set the Rain switch to "ON". Possible overheating of the snow melt cables may result.

Sensor Maintenance

At least once every four months the PM 2C should be powered down and the sensor grid be wiped clean with clear water. Heavy deposits left behind by evaporated water may be removed by gently scrubbing with a non-metallic scouring pad.

WARNING: This product contains chemicals known to the State of California to cause cancer and birth defects or other reproductive harm. For more information: www.watts.com/prop65

Limited Warranty: Watts Radiant (the "Company") warrants each product to be free from defects in material and workmanship under normal usage for a period of one year from the date of original shipment. In the event of such defects within the warranty period, the Company will, at its option, replace or recondition the product without charge.

THE WARRANTY SET FORTH HEREIN IS GIVEN EXPRESSLY AND IS THE ONLY WARRANTY GIVEN BY THE COMPANY WITH RESPECT TO THE PRODUCT. THE COMPANY MAKES NO OTHER WARRANTIES, EXPRESS OR IMPLIED. THE COMPANY HEREBY SPECIFICALLY DISCLAIMS ALL OTHER WARRANTIES, EXPRESS OR IMPLIED, INCLUDING BUT NOT LIMITED TO THE IMPLIED WARRANTIES OF MERCHANTABILITY AND FITNESS FOR A PARTICULAR PURPOSE.

The remedy described in the first paragraph of this warranty shall constitute the sole and exclusive remedy for breach of warranty, and the Company shall not be responsible for any incidental, special or consequential damages, including without limitation, lost profits or the cost of repairing or replacing other property which is damaged if this product does not work properly, other costs resulting from labor charges, delays, vandalism, negligence, fouling caused by foreign material, damage from adverse water conditions, chemical, or any other circumstances over which the Company has no control. This warranty shall be invalidated by any abuse, misuse, misapplication, improper installation or improper maintenance or alteration of the product.

Some States do not allow limitations on how long an implied warranty lasts, and some States do not allow the exclusion or limitation of incidental or consequential damages. Therefore the above limitations may not apply to you. This Limited Warranty gives you specific legal rights, and you may have other rights that vary from State to State. You should consult applicable state laws to determine your rights. **SO FAR AS IS CONSISTENT WITH APPLICABLE STATE LAW, ANY IMPLIED WARRANTIES THAT MAY NOT BE DISCLAIMED, INCLUDING THE IMPLIED WARRANTIES OF MERCHANTABILITY AND FITNESS FOR A PARTICULAR PURPOSE, ARE LIMITED IN DURATION TO ONE YEAR FROM THE DATE OF ORIGINAL SHIPMENT.**

WattsRadiant™
Floor Heating & Snow Melting

A Watts Water Technologies Company

USA: Tel: (800) 276-2419 • Fax: (417) 864-8161 • WattsRadiant.com

Canada: Tel: (888) 208-8927 • Fax: (905) 332-7068 • Watts.com

Latin America: Tel: (52) 81-1001-8600 • Fax: (52) 81-8000-7091 • WattsRadiant.com