

## For Non-Health Hazard Applications

Job Name \_\_\_\_\_

Contractor \_\_\_\_\_

Job Location \_\_\_\_\_

Approval \_\_\_\_\_

Engineer \_\_\_\_\_

Contractor's P.O. No. \_\_\_\_\_

Approval \_\_\_\_\_

Representative \_\_\_\_\_

# LEAD FREE\*

## Series 757, 757N Double Check Valve Assemblies

Sizes: 2½" – 10" (65 to 250mm)

Series 757, 757N Double Check Valve Assemblies are used to prevent backflow of non-health hazard pollutants that are objectionable but not toxic, from entering the potable water supply system. Series 757, 757N may be installed under continuous pressure service and may be subjected to backpressure and backsiphonage. Series 757, 757N consists of two independently operating check valves, two shutoff valves, and four test cocks.

### Features

- Extremely compact design
- 70% Lighter than traditional designs
- 304 (Schedule 40) Stainless steel housing & sleeve
- Groove fittings allow integral pipeline adjustment
- Patented tri-link check provides lowest pressure loss
- Unmatched ease of serviceability
- Available with grooved butterfly valve shutoffs
- Available for horizontal, vertical or N pattern installations
- Replaceable check disc rubber
- Sizes 2½", 3" and 4" (65, 80 and 100mm) available with quarter-turn ball valve shutoffs

### Specifications

The Double Check Valve Assembly shall consist of two independent tri-link check modules within a single housing, sleeve access port, four test cocks and two drip tight shut-off valves. Tri-link checks shall be removable and serviceable, without the use of special tools. The housing shall be constructed of 304 Schedule 40 stainless steel pipe with groove end connections. Tri-link checks shall have reversible elastomer discs and in operation shall produce drip tight closure against reverse flow caused by backpressure or backsiphonage. Assembly shall be a Watts Series 757, 757N.

\*The wetted surface of this product contacted by consumable water contains less than 0.25% of lead by weight.

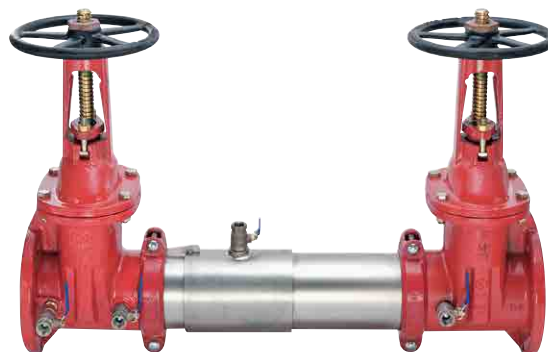

757OSY

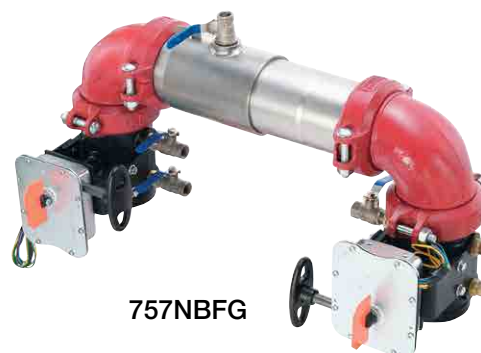

757NBFG

757OSY  
(Vertical)

### NOTICE

The information contained herein is not intended to replace the full product installation and safety information available or the experience of a trained product installer. You are required to thoroughly read all installation instructions and product safety information before beginning the installation of this product.

Watts product specifications in U.S. customary units and metric are approximate and are provided for reference only. For precise measurements, please contact Watts Technical Service. Watts reserves the right to change or modify product design, construction, specifications, or materials without prior notice and without incurring any obligation to make such changes and modifications on Watts products previously or subsequently sold.

The Watts logo, consisting of a stylized blue 'W' followed by the word 'WATTS' in bold black capital letters with a registered trademark symbol.

## Available Models

Suffix:

- NRS – non-rising stem resilient seated gate valves
- OSY – UL/FM outside stem and yoke, resilient seated gate valves
- BFG – UL/FM grooved gear operated butterfly valves with tamper switch
- QT – 2½", 3" and 4" (65, 80 and 100mm) quarter-turn ball valves
- \*\*OSY FxG – Flanged inlet gate connection and grooved outlet gate connection
- \*\*OSY GxF – Grooved inlet gate connection and flanged outlet gate connection
- \*\*OSY GxG – Grooved inlet gate connection and grooved outlet gate connection

Available with grooved NRS gate valves - consult factory\*\*

Post indicator plate and operating nut available - consult factory\*\*

\*\*Consult factory for dimensions

## Materials

Housing & Sleeve: 304 (Schedule 40) Stainless Steel

Elastomers: EPDM, Silicone and Buna-N

Tri-link Checks: Noryl®, Stainless Steel

Check Discs: Reversible Silicone or EPDM

Test Cocks: Bronze Body Nickel Plated

Pins & Fasteners: 300 Series Stainless Steel

Springs: Stainless Steel

## Pressure – Temperature

Temperature Range: 33°F – 140°F (0.5°C – 60°C)

Maximum Working Pressure: 175psi (12.1 bar)

## Approvals – Standards

- Approved by the Foundation for Cross-Connection Control and Hydraulic Research at The University of Southern California (FCCCHR-USC)



## Dimensions – Weight

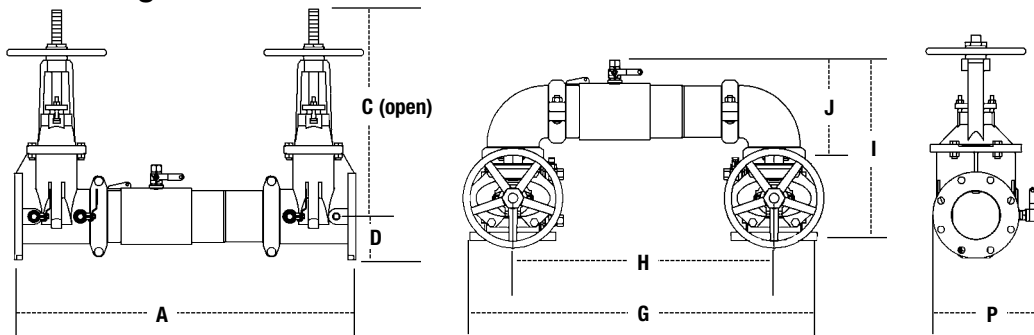

757, 757N

SIZE (DN)		DIMENSIONS									WEIGHT																
in.	mm	A	C (OSY)	C (NRS)	D	G	H	I	J	P	757NRS	757OSY	757N NRS	757N OSY													
in.	mm	in.	mm	in.	mm	in.	mm	in.	mm	in.	lbs.	kgs.	lbs.	kgs.													
2½	65	30¾	781	16⅞	416	9⅞	238	3½	89	29⅞	738	21½	546	15½	393	8⅞	223	9⅞	234	115	52	125	57	123	56	133	60
3	80	31¾	806	18⅞	479	10¼	260	3⅞	94	30¼	768	22¼	565	17⅞	435	9⅞	233	10½	267	131	59	145	66	144	65	158	72
4	100	33¾	857	22¾	578	12⅞	310	4	102	33	838	23½	597	18½	470	9⅞	252	11⅞	284	161	73	161	73	184	83	184	83
6	150	43½	1105	30⅞	765	16	406	5½	140	44¾	1137	33¼	845	23⅞	589	13⅞	332	15	381	273	124	295	134	314	142	336	152
8	200	49¾	1264	37¾	959	19⅞	506	6⅞	170	54⅞	1375	40⅞	1019	27⅞	697	15⅞	399	17⅞	437	438	199	480	218	513	233	555	252
10	250	57¾	1467	45¾	1162	23⅞	605	8⅞	208	66	1676	49½	1257	32½	826	17⅞	440	20	508	721	327	781	354	891	404	951	431

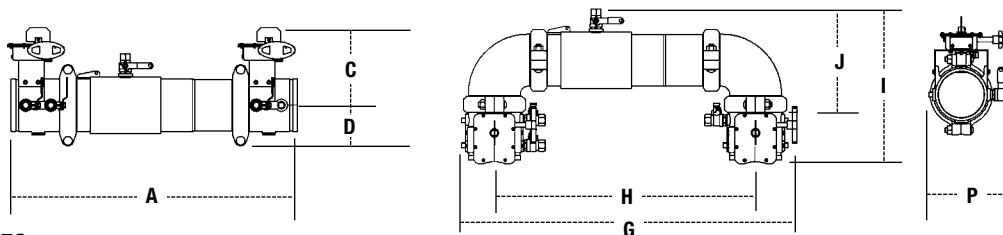

757BFG, 757NBFG

SIZE (DN)		DIMENSIONS									WEIGHT										
in.	mm	A	C	D	G	H	I	J	P	757BFG	757N BFG										
in.	mm	in.	mm	in.	mm	in.	mm	in.	mm	lbs.	kgs.	lbs.	kgs.								
2½	65	27¾	705	8	203	3½	89	29⅞	759	21½	546	14⅞	379	8⅞	223	9	229	56	25	64	29
3	80	28¼	718	8⅞	211	3⅞	94	30⅞	779	22¼	565	15⅞	392	9⅞	233	9½	241	54	24	67	30
4	100	29	737	8⅞	227	3⅞	94	31⅞	811	23½	597	16¼	412	9⅞	252	10	254	61	28	84	38
6	150	36½	927	10	254	5	127	43⅞	1097	33¼	845	19⅞	500	13⅞	332	10½	267	117	53	157	71
8	200	42¾	1086	12¼	311	6½	165	51⅞	1297	40⅞	1019	23⅞	592	15⅞	399	14⅞	361	261	118	337	153

Noryl® is a registered trademark of SABIC Innovative Plastics Holding BV.

## Dimensions — Weight continued

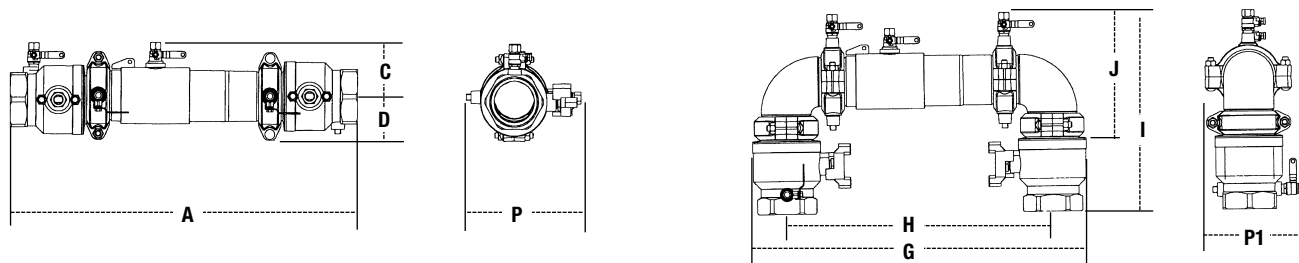

### 757QT

SIZE (DN)		DIMENSIONS										WEIGHT											
in.	mm	A		C		D		G		H		I		J		P		P1		QT		QTN	
		in.	mm	in.	mm	in.	mm	in.	mm	in.	mm	in.	mm	in.	mm	in.	mm	in.	mm	lbs.	kgs.	lbs.	kgs.
2½	65	27¼	692	4⅞	124	6⅞	175	30¼	768	24½	622	16¼	407	11⅜	289	11⅝	287	11⅝	287	40	18	50	23
3	80	28¼	718	4⅞	124	6⅞	175	30¼	768	24½	622	16¾	420	11⅜	289	11⅝	287	11⅝	287	50	23	60	27
4	100	31½	800	4⅞	124	6⅞	175	30¼	768	24½	622	18⅝	465	11⅜	289	11⅝	287	11⅝	287	70	32	80	36

# Capacity

Series 757, 757N flow curves as tested by Underwriters Laboratory.  
Flow characteristics collected using butterfly shutoff valves

—— Horizontal    —— Vertical    - - - - - N - Pattern

## Flow capacity chart identifies valve performance based upon rated water velocity up to 25fps

- Service Flow is typically determined by a rated velocity of 7.5fps based upon schedule 40 pipe.
- Rated Flow identifies maximum continuous duty performance determined by AWWA.
- UL Flow Rate is 150% of Rated Flow and is not recommended for continuous duty.
- AWWA Manual M22 [Appendix C] recommends that the maximum water velocity in services be not more than 10fps.

**2½" (65mm)**

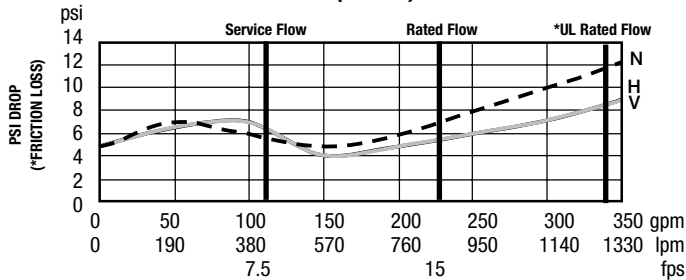

**6" (150mm)**

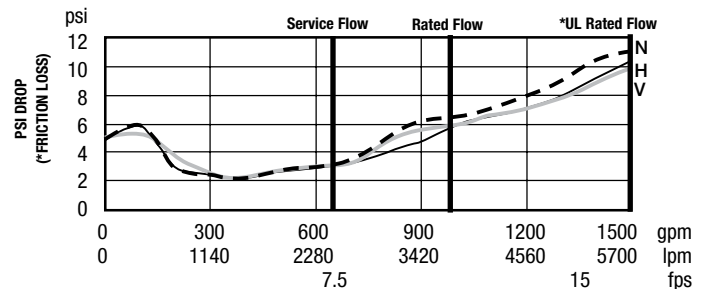

**3" (80mm)**

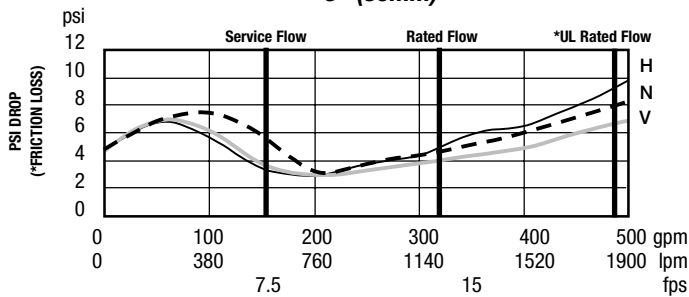

**8" (200mm)**

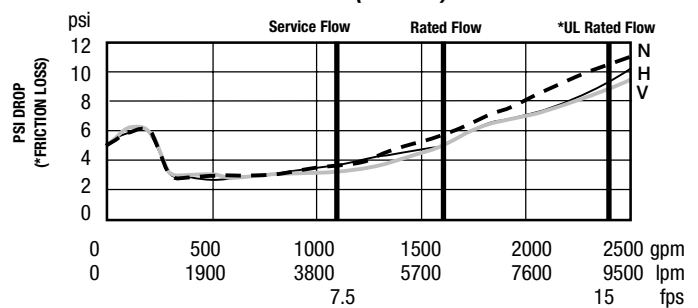

**4" (100mm)**

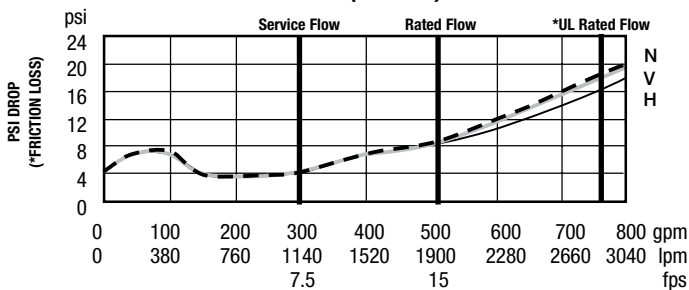

**10" (250mm)**

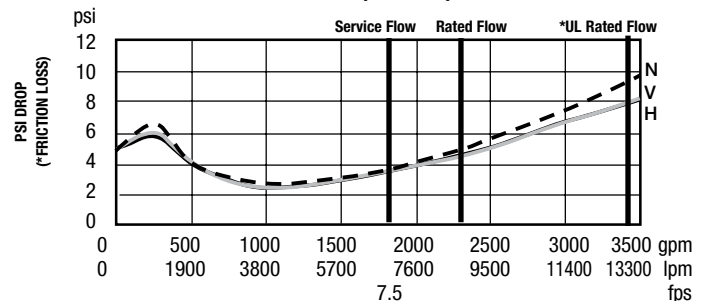

### NOTICE

Inquire with governing authorities for local installation requirements



A Watts Water Technologies Company

USA: Tel: (978) 689-6066 • Fax: (978) 975-8350 • Watts.com

Canada: Tel: (905) 332-4090 • Fax: (905) 332-7068 • Watts.com

Latin America: Tel: (52) 81-1001-8600 • Fax: (52) 81-8000-7091 • Watts.com