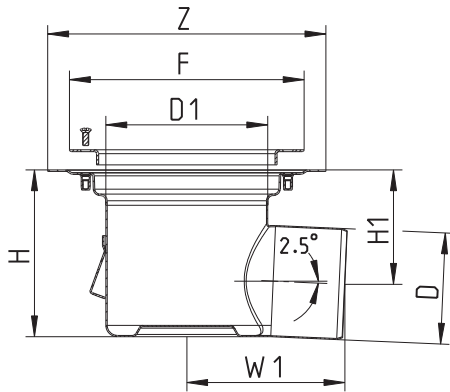

SPECIFICATION: BLÜCHER BFD-540-SO AISI Type 304 stainless steel floor drain with 12"(300) round top with surface membrane clamp, 1/8"(3) grating (standard), and no hub side outlet.

Side Outlet

Optional Gratings			
	Suffix	Description	
	-None	1/8" (Standard)	<input type="checkbox"/>
	-LG	Ladder Grating	<input type="checkbox"/>
	-MG	Mesh Grating	<input type="checkbox"/>
	-SG	Slot Grating	<input type="checkbox"/>

Options		
Suffix	Description	
-316	Type 316 Stainless Steel	<input type="checkbox"/>
-B	Sediment Basket	<input type="checkbox"/>
-P	Stainless Steel P-Trap	<input type="checkbox"/>
-SB	Sand Bucket	<input type="checkbox"/>
-TPT	Trap Primer Tapping	<input type="checkbox"/>
-VP	Grate Secured w/Vandal Proof Screws	<input type="checkbox"/>
-W	Water Trap	<input type="checkbox"/>

Dimensional Chart

Model No.	Pipe Size D	D1	Top Size F	Z	H	H1	W1
BFD-544-SO	4"(110)	10-1/4"(260)	13"(332)	14-3/4"(375)	5-3/16"(131)	5-3/16"(131)	8-1/8"(206)
BFD-546-SO	6"(160)	10-1/4"(260)	13"(332)	14-3/4"(375)	4-9/16"(115)	4-9/16"(115)	13-7/16"(341)

Job Name _____ Contractor _____

Job Location _____ Approval _____

Engineer _____ Contractor's P.O. No. _____

Approval _____ Representative _____