

Job Name _____

Contractor _____

Job Location _____

Approval _____

Engineer _____

Contractor's P.O. No. _____

Approval _____

Representative _____

LEAD FREE*

Series LF800M4QT Anti-Siphon Pressure Vacuum Breakers

Sizes: ½" – 2"

Series LF800M4QT is designed to prevent backsiphonage of contaminated water into a potable water supply. The valve is ideally suitable for irrigation systems, industrial process water systems and other continuous pressure piping system applications where the water enters the equipment at or below its flood rim. The disc float and check valve are suitable for temperatures up to 140°F. The resilient sealing float O-ring and seal check disc are silicone rubber which is resistant to heat, shock and chemical attack. The LF800M4QT features Lead Free* construction to comply with Lead Free* installation requirements.

Features

- Replaceable plastic seat
- Easy maintenance of internal parts
- Acetal bonnet acts as "freeze plug" to prevent body damage
- O-ring bonnet seal for less possibility of fouling
- Silicone seat disc for durability
- Test cocks positioned for easy testing and winterization
- Compact space saving design
- Standardly equipped with tee handle quarter turn ball valve shutoffs ½" – 1". The 1¼" - 2" feature lever handles.
- No special tools required for servicing
- Lead Free* cast copper silicon alloy

Specifications

Pressure Vacuum Breakers

An anti-siphon pressure vacuum breaker shall be installed where indicated on the plans to prevent the backsiphonage of contaminated water. This assembly is not to be used where there is a possibility that a back pressure condition may develop. The assembly will incorporate an acetal bonnet with silicone rubber O-ring seal and silicone rubber seat disc. The valve shall have replaceable seats. Check assembly shall be guided over its full stroke by 'V' notched guides. The Lead Free* Anti-Siphon Pressure Vacuum Breakers shall comply with state codes and standards, where applicable, requiring reduced lead content. The assembly shall meet the requirements of ANSI/ASSE Standard 1020 and shall be a Watts LF800M4QT.

*The wetted surface of this product contacted by consumable water contains less than 0.25% of lead by weight.

Watts product specifications in U.S. customary units and metric are approximate and are provided for reference only. For precise measurements, please contact Watts Technical Service. Watts reserves the right to change or modify product design, construction, specifications, or materials without prior notice and without incurring any obligation to make such changes and modifications on Watts products previously or subsequently sold.

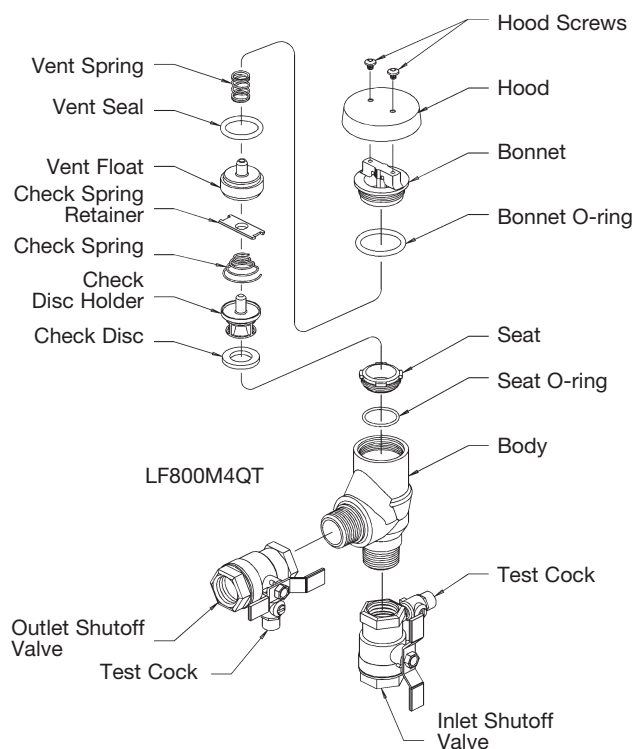
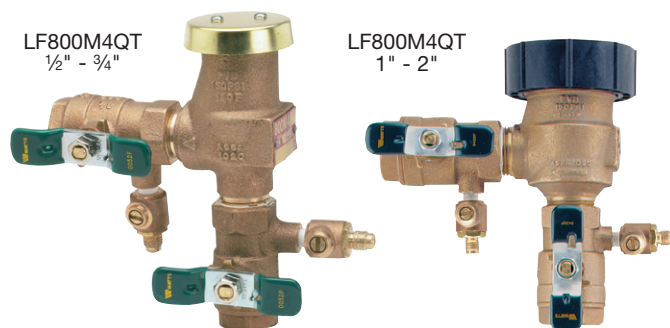

**Now Available
WattsBox Insulated Enclosures.**

For more information, send for literature ES-WB.

NOTICE

The information contained herein is not intended to replace the full product installation and safety information available or the experience of a trained product installer. You are required to thoroughly read all installation instructions and product safety information before beginning the installation of this product.

NOTICE

Inquire with governing authorities for local installation requirements

WATTS®

Materials

Springs:	Stainless Steel
Bonnet:	Celcon®
Vent Disc:	Silicone Rubber
Disc Holder Float:	Polypropylene
Check Valve Disc:	Silicone Rubber
Check Valve Seat:	Noryl® Plastic
Body:	Lead Free* Cast Copper Silicon Alloy

Pressure — Temperature

Temperature Range: 33°F to 140°F (0.5°C to 60°C)

Maximum Working Pressure: 150psi (10.3 bar)

Installations

This valve is designed for installation in a continuous pressure potable water supply system 12" above the highest point of the downstream piping. The valve must be installed with the supply connected to the bottom and in a vertical position. Allow adequate space for periodic inspection, servicing or testing. The valve should not be installed in an area where freezing or spillage will cause damage. Adequate drainage/freeze protection must be provided in cold weather applications. 1.5psi (10 kPa) must be exerted against the float spring to seal the float and air inlet. Do not undersize supply and discharge piping.

NOTICE

Vacuum breakers are not designed, tested or approved to protect against backpressure backflow or water hammer shock. For protection against backpressure backflow, install Watts LF009 Reduced Pressure Zone Backflow Preventer. For protection against water hammer shock install a Watts Series LF15 Water Hammer Arrestor utilizing good plumbing practice.

Dimensions – Weights

LF800M4QT

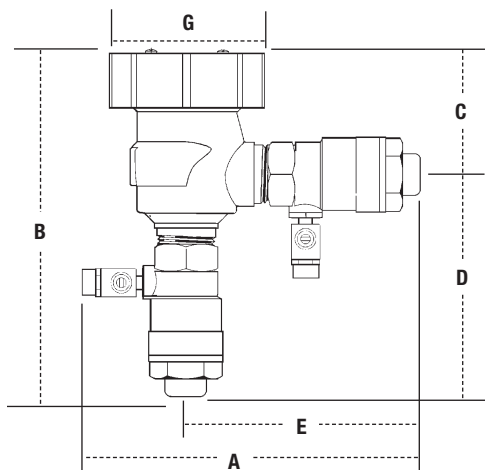

Standards

ANSI, USC Manual Section 10

Approvals



Approved by the foundation for Cross-Connection Control and Hydraulic Research at the University of Southern California, Manual Section 10. 1/2", 3/4", 1 1/4", 1 1/2", 2" 1" pending CSA 1/2" – 2"

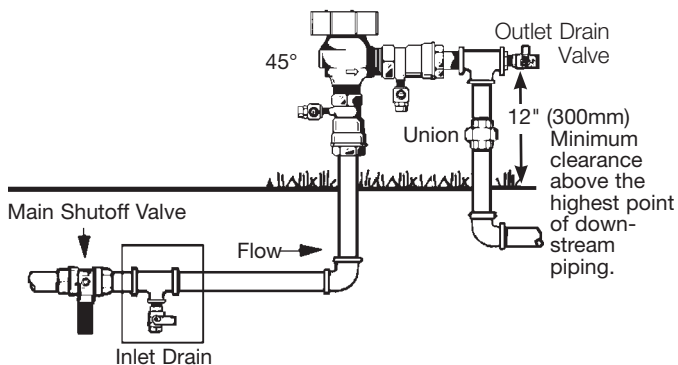

Freeze Protection Guidelines

1. Close main shutoff valve.
2. Open upstream drain, test cocks and isolation ball valves to depressurize line.
3. Purge with air.
4. Leave test cocks and isolation ball valve handles in 45° angle to drain ball valves and prevent casting damage.

MODEL	SIZE	DIMENSIONS										WEIGHT			
		A		B		C		D		E		G		lbs.	kg
	in.	in.	mm	in.	mm	in.	mm	in.	mm	in.	mm	in.	mm		
LF800M4QT	1/2	6 1/8	156	6 1/4	159	2 7/16	65	3 1/16	94	3 3/8	98	2 1/4	57	4	1.8
LF800M4QT	3/4	6 1/2	165	6 1/2	165	2 7/16	65	3 5/16	100	4 1/8	105	2 1/4	57	4	1.8
LF800M4QT	1	7 1/2	191	7 1/2	191	2 3/4	70	4 3/4	121	4 7/8	124	3 1/16	87	6	2.7
LF800M4QT	1 1/4	8 7/8	225	9	229	3 1/4	83	5 3/4	146	6 1/8	156	5	127	11	5.0
LF800M4QT	1 1/2	9 1/4	235	9 1/2	241	3 1/4	83	6 1/4	159	6 3/8	162	5	127	14	6.3
LF800M4QT	2	10 5/8	270	9 5/8	245	3 3/4	83	6 3/8	162	7	178	5	127	19	8.6

Noryl® is a registered trademark of SABIC Innovative Plastics Holding BV.
Celcon® is a registered trademark of Celanese Corporation.

Capacity

As compiled from documented Foundation for Cross-Connection Control and Hydraulic Research at the University of Southern California lab tests.

**Typical maximum flow rate (7.5 feet/sec.)

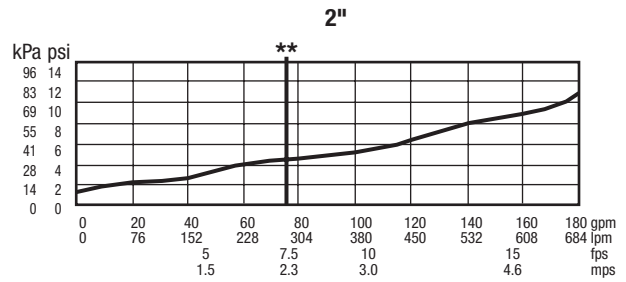
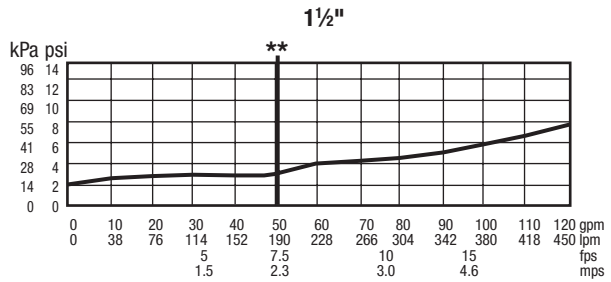
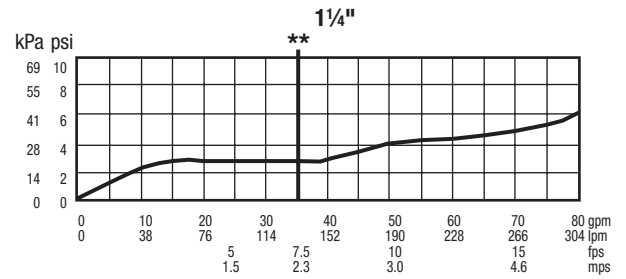
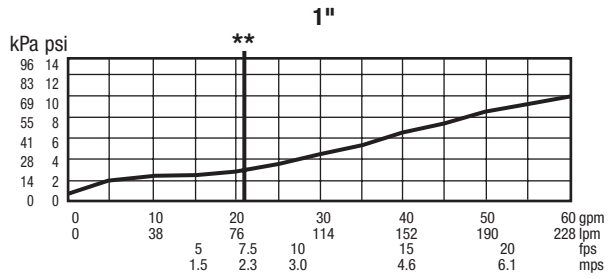
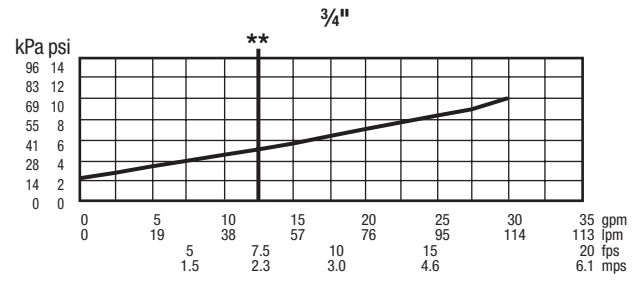
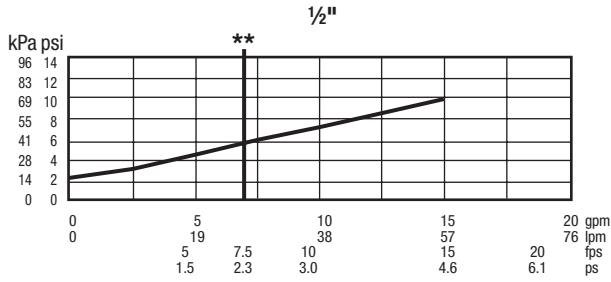

USA: T: (978) 689-6066 • F: (978) 975-8350 • Watts.com
 Canada: T: (905) 332-4090 • F: (905) 332-7068 • Watts.ca
 Latin America: T: (52) 81-1001-8600 • Watts.com