

MixTemp 180™ Submittal

PROJECT NAME: _____

WATTS RADIANT REPRESENTATIVE: _____

Unit Tag No.: _____ Order No.: _____ Date: _____

Engineer: _____ Submitted by: _____ Date: _____

Contractor: _____ Approved by: _____ Date: _____

MixTemp 180™ Mix Valve

Non-electric, 100°–180°F, 3-port Hydronic Mix Valve

3/4" MixTemp 180 Mix Valve
 Model number 70305
 Order number 81000710

1" MixTemp 180 Mix Valve
 Model number 703100
 Order number 81000711

PRODUCT SPECIFICATIONS

The MixTemp 180 is a 3-port, non-electric mix valve for use in hydronic heating systems. This mix valve is capable of delivering water temperatures ranging from 100° to 180°F. The hydronic mix valve shall have a cast bronze body with copper, brass and polysulfone internal parts. There are no ferrous components to corrode. The actuator for the piston shall have lineal expansion characteristics, and shall be completely filled with a temperature-sensitive wax. Each port on the MixTemp has a union to allow for easy servicing, if necessary. The MixTemp 180 is available in 3/4" and 1" female NPT fittings.



Mix valves are available in 3/4" and 1" female NPT union fittings.

METHOD OF OPERATION

The wax-filled thermostatic actuator is located in the valve mixing chamber, where the tempered water flows over it. A rise in mix temperature causes the wax to expand. This type of thermostat is linear in its expansion and exerts its operating force directly on the valve piston, reducing the proportion of hot water and increasing the proportion of cold. The wax-filled thermostatic actuator is sensitive to the slightest variation in the mix temperature and reacts quickly to changes in operating conditions.

MAINTENANCE AND ADJUSTMENT

The MixTemp 180 is non-electric, corrosion-resistant, and requires minimal service. Hot, cold, and mix ports are clearly marked "H," "C," and "M," respectively. To adjust the water temperature, back out the allen screw on top of the red knob until the allen screw is barely engaged. Lift the red knob up until it disengages from the locking teeth on the valve body (about 1/2"). Now turn the knob clockwise for cooler, or counterclockwise for a warmer setting. When you have the desired temperature setting, let the system run 3 minutes to confirm the setting. Once you are sure of the setting, push the red knob back down until the locking teeth engage. Last, set the allen screw to lock the valve at your setting. Note that it takes about 4-1/2 turns to go from 100° to 180°F. Turning the adjustment knob into the full hot position

will supply boiler temperature water. To avoid this, simply turn the knob one-half turn back from the full hot position.

SUGGESTED APPLICATION

MixTemp 180 mix valves are designed to be a simple, durable solution for residential hydronic system designers who require multiple water temperatures in a single system. Their use is essential where a hydronic system requires lower temperatures be delivered to radiant panel zones and higher temperatures be delivered to baseboard, fan coil, or other high-temperature zones. Watts Radiant hydronic MixTemp 180 valves are most commonly used in lower temperature residential primary/secondary pumping applications. Typically, a primary boiler loop operating at 140° to 190°F distributes heat to one or more hydronic distribution zones. Where these mixed hydronic distribution zones typically require fluid temperatures ranging from 100° to 180°F a MixTemp valve is appropriate. Normally, each valve requires its own circulator.

GENERAL INSTRUCTIONS

Please read instructions completely before starting work. All work must be performed by qualified personnel in accordance with all applicable codes and ordinances.

CAUTION: These mixing valves are not anti-scald valves since they do not have positive shut-off in case of failure of hot or cold water supply. **We do not recommend their use for shower service.**

INSTALLATION NOTES

Always plumb the zone circulators downstream of the mix valves. Use spring check valves on supply lines to prevent thermosiphoning to zones above the mechanical room. The mix valves must have a source of return water cooler than the desired mix temperature to operate properly. Use only the return water from the zone(s) serviced by the mix valve as the source feeding the cold port. Do not combine hot returns (as from baseboard zones) with cooler returns from radiant floor zones. The hot port and the cold of the valve must have approximately the same water pressure for the valve to mix properly.

MixTemp 180 Mix Valve C_v Values

MixTemp 180 Mix Valve Size	C _v Value
3/4" (100°–180°F)	3.1
1" (100°–180°F)	3.2

TYPICAL MIXTEMP 180 VALVE APPLICATIONS

Radiant Addition to an Existing Hydronic System

A lower temperature radiant floor addition is piped into an existing high temperature heating circuit. A zone thermostat activates the zone circulator. The circulator *must be plumbed downstream of the mix valve*. A strainer removes any existing debris from the system. A spring check valve prevents thermosiphoning to upper zones.

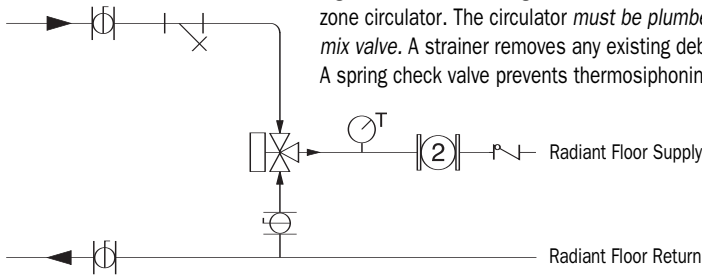





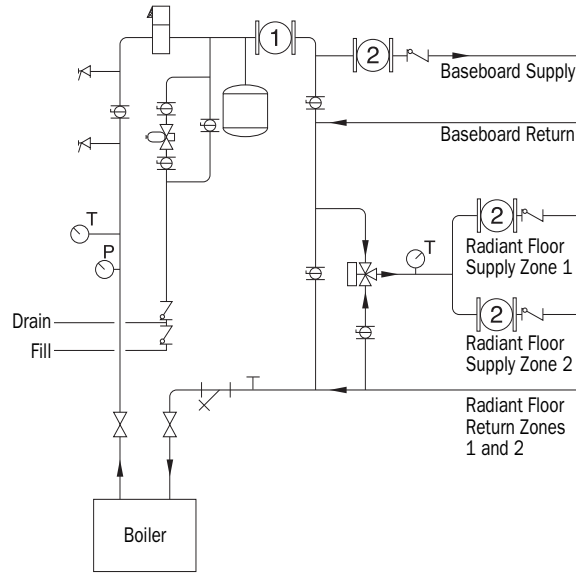











Mixed Radiant and Baseboard System

Two radiant floor zones, each requiring similar delivery water temperatures, are piped off the same mix valve. Make sure that the combined flow of both zones does not exceed the capacity of the valve at a 1 psi pressure drop across the mix valve. Use circulators of similar capacity and radiant circuits of approximately the same circuit length when you use this application. A third hot water baseboard zone is also piped off the primary boiler loop. Similarly, another zone servicing an indirect hot water heater or hot water fancoil (not illustrated) can be treated like the baseboard zone shown here. A spring check valve prevents thermosiphoning to upper zones.



Legend to Schematics

-  Primary Pump
-  Secondary Pump
-  Micro-bubble Oxygen Remover
-  MixTemp 180 Valve
-  Zone Valve
-  Wye Strainer
-  Ball Valve
-  Boiler Drain
-  Check Valve
-  Pete's Plug
-  Gate Valve
-  Primary Purge Assembly
-  Fill Valve
-  Expansion Tank
-  Backflow Preventer
-  Pressure Gauge
-  Temperature Gauge

Three-Zone Radiant System

Three zones are piped off of a primary loop. One radiant floor zone is served by a dedicated circulator. Two other radiant floor zones are served by a second circulator with two thermostatically controlled conventional zone valves. Mix valves reduce the delivery water feeding each circulator to the correct temperature, while maintaining the primary boiler loop above the condensing point. Always plumb the circulators downstream of the mix valves. A spring check valve prevents thermosiphoning to upper zones.

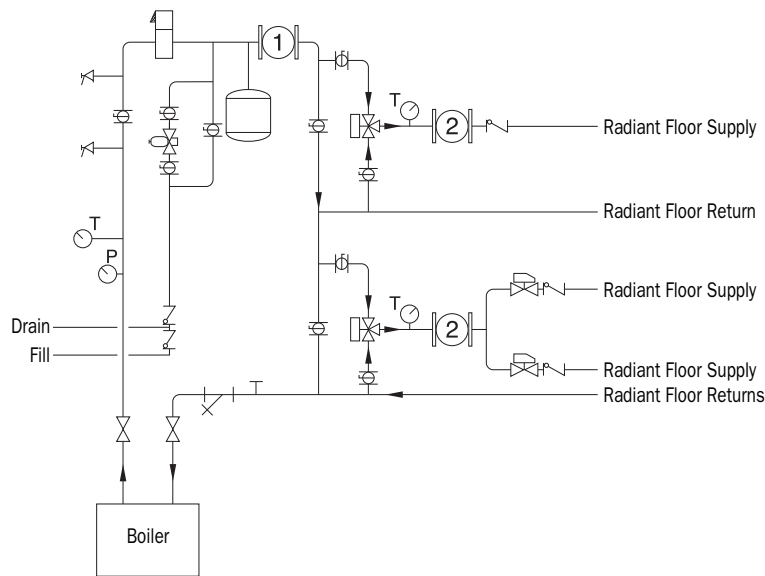

WARNING: The mix valve must not be heated in excess of 190°F (92°C). Exposure to supply temperatures in excess of 190°F may cause the valve to fail.

CAUTION: Turn off water before servicing. Open supply valves slowly to prevent water hammer or sudden shock. Wear heat-resistant gloves while making adjustments.

Making Temperature Adjustments: To ensure accuracy in adjusting the temperature setting, make sure that the hot water supply temperature to the valve is at least 1.0°F (5°C) hotter than the desired temperature of the mixed water. The use of a permanent temperature monitor, such as a dial gauge or a Watts Radiant StickTemp™, is suggested for correct calibration of the valve.