

# Watts Safety Relief Valves For Steam, Air, Gas And Vapors

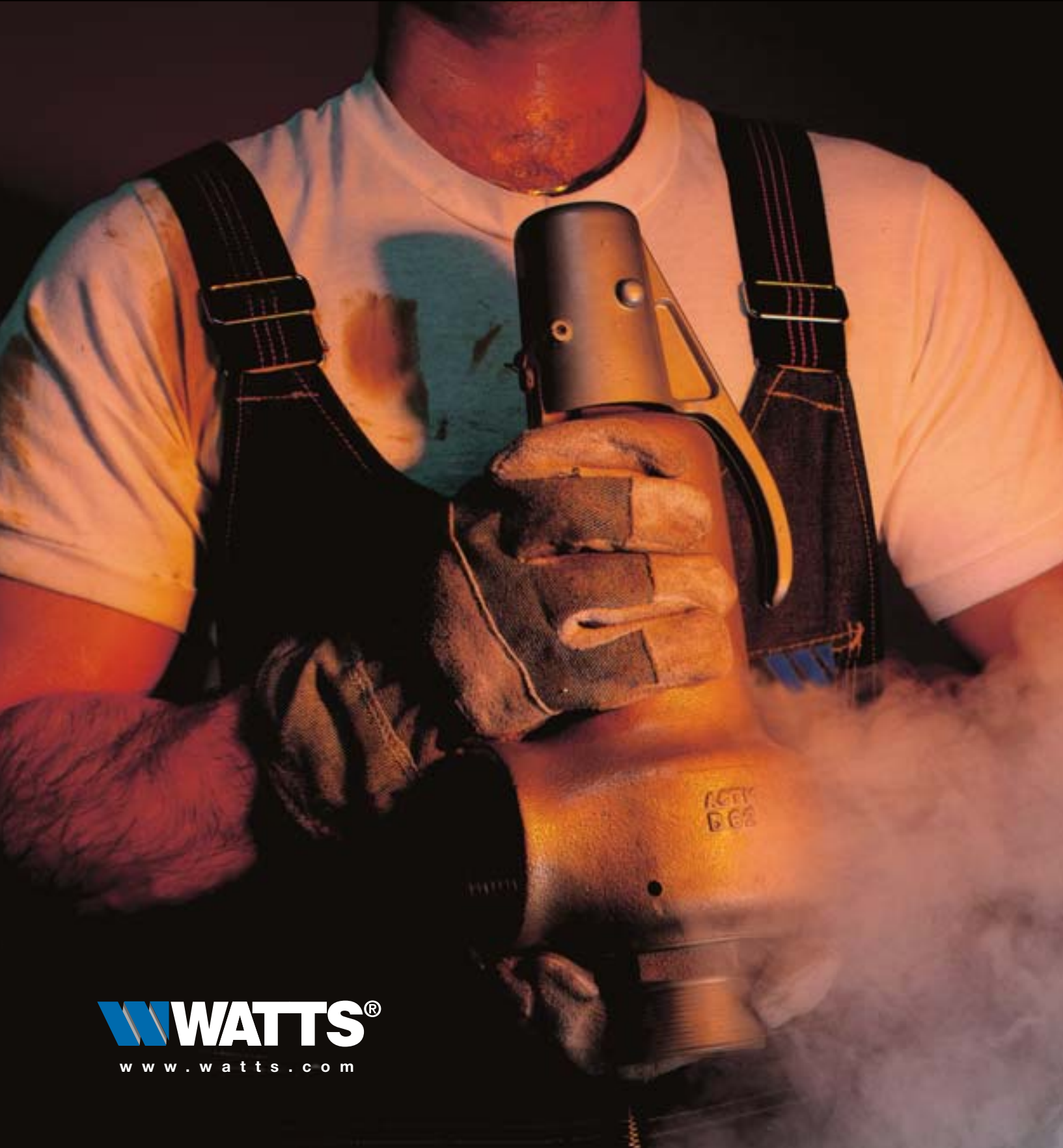

# Contents

Model	Page
Typical Installations . . . . .	.3
Fig. 31 - ASME Section I . . . . .	.4
Fig. 41 - ASME Section VIII . . . . .	.5
Fig. 41A - ASME Section VIII . . . . .	.6
Fig. 31/41/41A Dimensions/Weights/Materials . . . . .	.7-8
Fig. 31/41/41A Ordering Information . . . . .	.9
Series 315/415 - ASME Section IV . . . . .	.10
Fig. 10 - ASME Section IV . . . . .	.11

## Introduction

Watts Safety Relief Valves offer economical safety with Watts quality for use in steam, air, gas and vapor applications. All our safety relief valves are manufactured to meet or exceed the performance and overprotection criteria established by ASME code section I, IV and VIII requirements. To accomplish this, all Watts Safety Relief Valves are 100% inspected and tested for set point, blowdown, and seat tightness by an ASME certified valve assembly and repair facility.

Watts Safety Relief Valves feature a two-ring design that ensures sharp opening action and short blowdown, providing over-pressure protection with minimal loss of steam, gas, or vapor. Our valves have a top guided, full nozzle, high capacity design to minimize valve wear and provide longer service life. The cap/lifting lever design allows for easy manual testing and the optically flat lapped seating surfaces ensure maximum seat tightness. Watts Safety Relief Valves are available in both bronze and cast iron body construction in a range of sizes for a variety of applications as outlined in the following pages of this guide.

We have also included saturated steam capacity charts that have been certified by the National Board of Boiler and Pressure Vessel Inspectors to assist you in selecting the proper relief valve for your application.

## How to Use Saturated Steam Capacities Charts

This guide presents saturated steam capacity charts to help you determine the pounds per hour capacity of Watts Safety Relief Valves.

It is important to note that the relief valve capacity must exceed the boiler's pound per hour capacity in ASME Section I boiler applications and must exceed the pound per hour capacity of the steam service valves in ASME Section VIII applications.

For example, to size the Fig. 31 Safety Relief Valve, you need to know the set pressure and steam capacity in pounds per hour the valve must relieve. Assume a set point of 45psi and a boiler capacity of 9500 lbs/hr. Using Chart 1 below, locate the set pressure of 45psi in the left hand column. Read across the row until you find a capacity greater than 9500 lbs/hr, the capacity of the boiler. The first one you will see is 10,351. Read up the column to find the orifice size of the valve required to relieve enough capacity at 45psi set point. You will require a "M" orifice. Refer to the ordering information charts on page 9. Locate the valve size column and read down, you will find that a Watts 3x4 Figure 31 Safety Relief Valve satisfies the M orifice requirements.

Chart 1

WATTS FIG. 31 ASME SECTION I SERIES VALVES SATURATED STEAM CAPACITIES (LBS/HR @ 90% RATING AND 3% OVERPRESSURE)													
Orifice Area (in <sup>2</sup> )	D	E	F	G	H	J	K	L	M	N	P	Q	R
Set Press. psi	0.1188	0.2116	0.3318	0.5424	0.8479	1.391	1.892	2.935	3.715	4.468	6.564	11.365	16.475
35	277	494	774	1266	1979	3247	4416	6851	8674	10429	15321	26527	38455
40	304	542	849	1388	2171	3561	4843	7513	9512	11437	16803	29093	42174
45	331	589	924	1511	2362	3875	5270	8176	10351	12446	18285	31658	45893
50	358	637	999	1633	2553	4189	5697	8838	11190	13455	19766	34224	49612

# Typical Installations

Below are some of the typical safety relief valve installations.\*

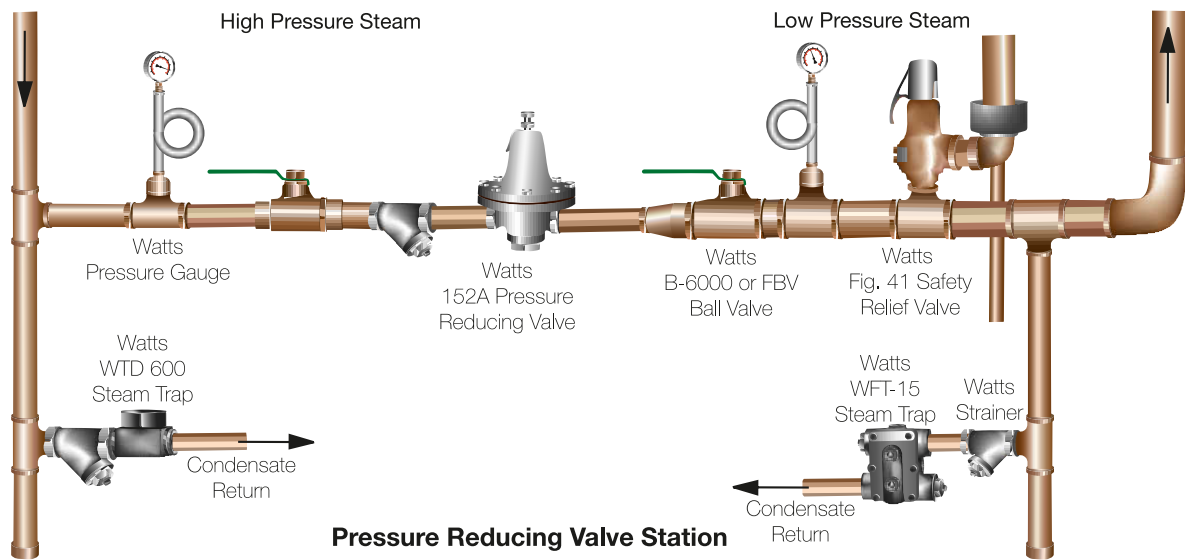
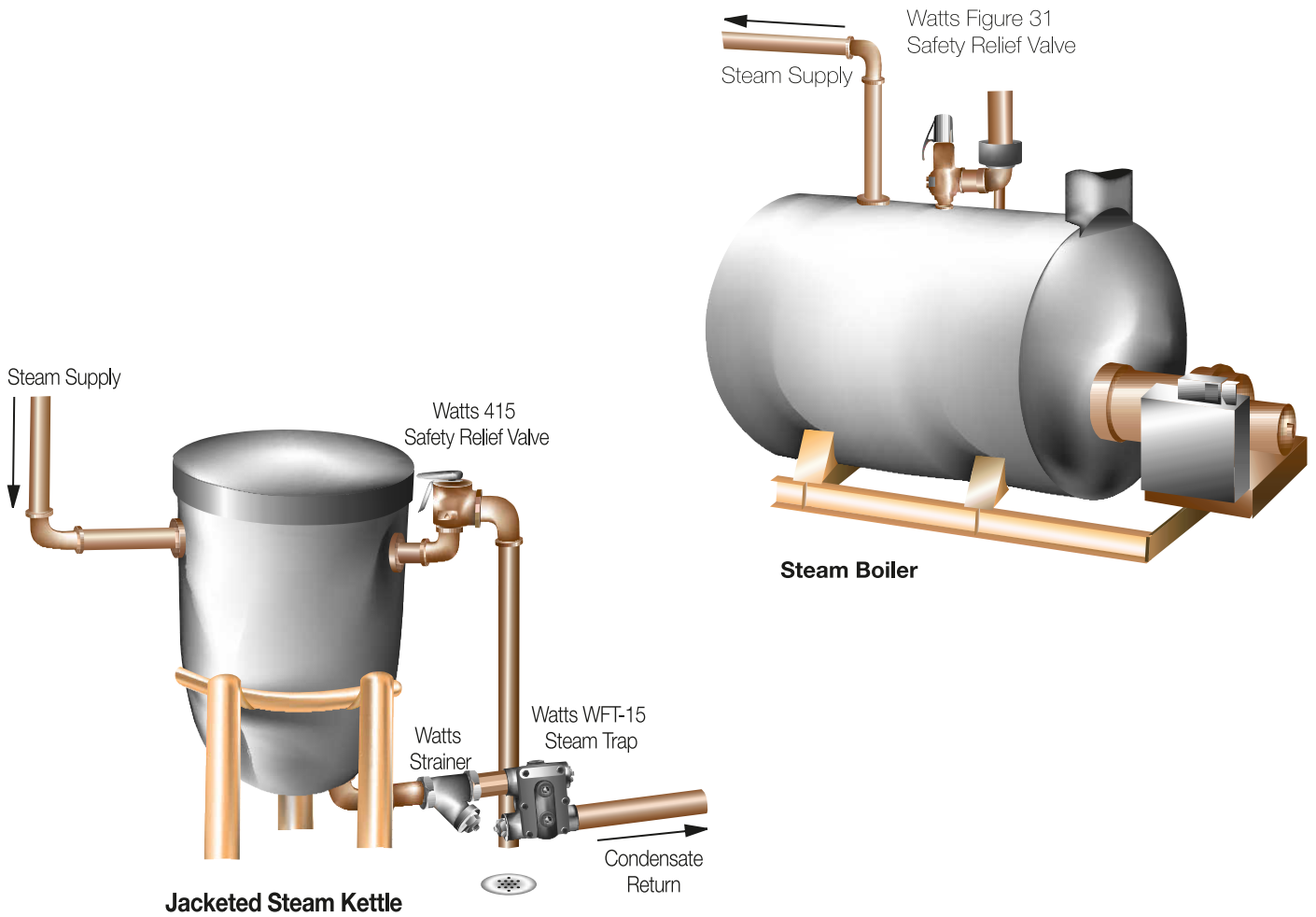

\* Consult with equipment manufacturer for actual piping arrangement.

# Watts Bronze and Cast Iron Safety Relief Valves

for steam boilers with pressures to 250psi at 406°F



**Fig. 31 - ASME Section I**

## Applications

Figure 31 is a top guide, high capacity, full nozzle safety relief valve available in bronze or cast iron for over pressure protection of steam boilers with operating pressures from 5 to 250psi.

## Features

Unitized bonnet/base design, rugged construction and 2-ring control make the Figure 31 safety relief valve extremely dependable in terms of pop action, seat tightness and repeatability. The single unit cap and lifting lever permit manual valve opening (testing) with low required force on the lever.

## Size/Ratings

Bronze valves are available in twelve sizes ranging from 1/2" x 3/4" to 2 1/2" x 2 1/2", connections are male NPT screwed inlet and female NPT screwed outlet. Cast iron valves are available in sixteen sizes ranging from 1 1/2" x 2 1/2" to 6" x 8". Rating is 250psi at 406°F saturated steam.

**WATTS Fig. 31 ASME Section I Series Valves Saturated Steam Capacities (lbs/hr @ 90% rating and 3% overpressure)**

Orifice Area (in <sup>2</sup> )	D 0.1188	E 0.2116	F 0.3318	G 0.5424	H 0.8479	J 1.391	K 1.892	L 2.935	M 3.715	N 4.468	P 6.564	Q 11.365	R 16.475
Set Press. psi													
15	170	303	475	776	1213	1991	2708	4200	5318	6394	9394	16265	23579
20	197	351	550	899	1405	2305	3135	4863	6157	7403	10876	18831	27298
25	224	398	625	1021	1596	2619	3562	5526	6996	8412	12358	21396	31017
30	250	446	700	1144	1788	2933	3989	6188	7835	9420	13839	23962	34736
35	277	494	774	1266	1979	3247	4416	6851	8674	10429	15321	26527	38455
40	304	542	849	1388	2171	3561	4843	7513	9512	11437	16803	29093	42174
45	331	589	924	1511	2362	3875	5270	8176	10351	12446	18285	31658	45893
50	358	637	999	1633	2553	4189	5697	8838	11190	13455	19766	34224	49612
55	385	685	1074	1756	2745	4503	6125	9501	12029	14463	21248	36789	53331
60	411	733	1149	1878	2936	4817	6552	10163	12868	15472	22730	39355	57050
65	438	780	1224	2001	3128	5131	6979	10826	13707	16480	24212	41920	60769
70	466	829	1300	2126	3323	5451	7414	11502	14562	17509	25723	44537	64562
75	493	878	1377	2252	3520	5774	7854	12184	15426	18548	27249	47180	68393
80	521	928	1455	2378	3717	6098	8294	12866	16290	19587	28775	49822	72223
85	548	977	1532	2504	3914	6421	8734	13549	17154	20626	30302	52464	76054
90	576	1026	1609	2630	4111	6745	9174	14231	18018	21665	31828	55107	79884
95	604	1075	1686	2756	4308	7068	9614	14914	18882	22703	33354	57749	83715
100	631	1124	1763	2882	4506	7392	10054	15596	19746	23742	34880	60392	87546
105	659	1174	1840	3008	4703	7715	10494	16279	20610	24781	36406	63034	91376
110	687	1223	1917	3134	4900	8038	10934	16961	21474	25820	37932	65677	95207
115	714	1272	1995	3261	5097	8362	11374	17643	22338	26859	39459	68319	99037
120	742	1321	2072	3387	5294	8685	11813	18326	23202	27898	40985	70962	102868
125	769	1370	2149	3513	5491	9009	12253	19008	24066	28937	42511	73604	106699
130	797	1420	2226	3639	5688	9332	12693	19691	24930	29975	44037	76247	110529
135	825	1469	2303	3765	5886	9655	13133	20373	25794	31014	45563	78889	114360
140	852	1518	2380	3891	6083	9979	13573	21055	26658	32053	47090	81532	118190
145	880	1567	2457	4017	6280	10302	14013	21738	27522	33092	48616	84174	122021
150	908	1616	2535	4143	6477	10626	14453	22420	28386	34131	50142	86817	125851
155	935	1666	2612	4269	6674	10949	14893	23103	29250	35170	51668	89459	129682
160	963	1715	2689	4396	6871	11273	15333	23785	30114	36208	53194	92101	133513
165	990	1764	2766	4522	7068	11596	15773	24468	30978	37247	54721	94744	137343
170	1018	1813	2843	4648	7266	11919	16212	25150	31842	38286	56247	97386	141174
175	1046	1862	2920	4774	7463	12243	16652	25832	32706	39325	57773	100029	145004
180	1073	1912	2997	4900	7660	12566	17092	26515	33570	40364	59299	102671	148835
185	1101	1961	3075	5026	7857	12890	17532	27197	34434	41403	60825	105314	152666
190	1128	2010	3152	5152	8054	13213	17972	27880	35298	42442	62351	107956	156496
195	1156	2059	3229	5278	8251	13537	18412	28562	36162	43480	63878	110599	160327
200	1184	2108	3306	5404	8448	13860	18852	29244	37026	44519	65404	113241	164157
205	1211	2158	3383	5531	8646	14183	19292	29927	37890	45558	66930	115884	167988
210	1239	2207	3460	5657	8843	14507	19732	30609	38754	46597	68456	118526	171818
215	1267	2256	3538	5783	9040	14830	20172	31292	39618	47636	69982	121169	175649
220	1294	2305	3615	5909	9237	15154	20612	31974	40482	48675	71509	123811	179480
225	1322	2354	3692	6035	9434	15477	21051	32656	41346	49714	73035	126453	183310
230	1349	2404	3769	6161	9631	15800	21491	33339	42210	50752	74561	129096	187141
235	1377	2453	3846	6287	9829	16124	21931	34021	43074	51791	76087	131738	190971
240	1405	2502	3923	6413	10026	16447	22371	34704	43938	52830	77613	134381	194802
245	1432	2551	4000	6540	10223	16771	22811	35386	44802	53869	79140	137023	198633
250	1460	2600	4078	6666	10420	17094	23251	36069	45666	54908	80666	139666	202463



# Watts Bronze and Cast Iron Safety Relief Valves

for saturated steam to 250psi at 406°F



**Fig. 41 - ASME Section VIII Steam Service**

## Applications

Figure 41 is a top guide, high capacity, full nozzle safety relief valve for over-pressure protection on unfired pressure vessels, steam pressure reducing valve stations and other steam service applications with operating pressures from 5 to 250psi.

## Features

Unitized bonnet/base design, rugged construction and 2-ring control make the Figure 41 safety relief valve extremely dependable in terms of pop action, seat tightness and repeatability. The single unit cap and lifting lever permit manual valve opening (testing) with low required force on the lever.

## Size/Ratings

Bronze valves are available in twelve sizes ranging from 1/2" x 3/4" to 2 1/2" x 2 1/2", connections are male NPT screwed inlet and female NPT screwed outlet. Cast iron valves are available in sixteen sizes ranging from 1 1/2" x 2 1/2" to 6" x 8". Rating is 250psi at 406°F saturated steam.

**WATTS Fig. 41 ASME Section VIII Series Valves Saturated Steam Capacities (lbs/hr @ 90% rating and 10% overpressure)**

Orifice Area (in <sup>2</sup> )	D 0.1188	E 0.2116	F 0.3318	G 0.5424	H 0.8479	J 1.391	K 1.892	L 2.935	M 3.715	N 4.468	P 6.564	Q 11.365	R 16.475
Set Press. psi													
15	176	313	491	802	1254	2057	2798	4340	5494	6606	9706	16804	24360
20	203	361	566	925	1445	2371	3225	5003	6335	7617	11190	19374	28085
25	229	409	641	1047	1637	2686	3653	5667	7175	8627	12674	21943	31809
30	256	456	716	1170	1829	3000	4081	6330	8015	9637	14158	24513	35534
35	286	509	798	1305	2040	3346	4551	7060	8939	10748	15790	27339	39631
40	315	562	881	1440	2251	3692	5022	7790	9863	11859	17422	30165	43729
45	345	614	963	1575	2461	4038	5492	8520	10787	12970	19055	32992	47826
50	374	667	1046	1709	2672	4384	5963	9250	11711	14081	20687	35818	51923
55	404	720	1128	1844	2883	4730	6433	9980	12636	15193	22320	38645	56020
60	434	772	1211	1979	3094	5076	6904	10710	13560	16304	23952	41471	60117
65	463	825	1293	2114	3305	5422	7374	11440	14484	17415	25585	44297	6U-1-5
70	493	877	1376	2249	3516	5768	7845	12170	15408	18526	27217	47124	68312
75	522	930	1458	2384	3727	6114	8316	12900	16332	19637	28849	49950	72409
80	552	983	1541	2519	3937	6460	8786	13630	17256	20748	30482	52777	76506
85	581	1035	1623	2654	4148	6805	9257	14359	18180	21860	32114	55603	80604
90	611	1088	1706	2789	4359	7151	9727	15089	19105	22971	33747	58429	84701
95	640	1140	1788	2923	4570	7497	10198	15819	20029	24082	35379	61256	88798
100	670	1193	1871	3058	4781	7843	10668	16549	20953	25193	37012	64082	92895
105	699	1246	1953	3193	4992	8189	11139	17279	21877	26304	38644	66909	96992
110	729	1298	2036	3328	5203	8535	11609	18009	22801	27415	40276	69735	101090
115	758	1351	2118	3463	5414	8881	12080	18739	23725	28527	41909	72561	105187
120	788	1404	2201	3598	5624	9227	12550	19469	24649	29638	43541	75388	109284
125	818	1456	2283	3733	5835	9573	13021	20199	25574	30749	45174	78214	113381
130	847	1509	2366	3868	6046	9919	13491	20929	26498	31860	46806	81041	117479
135	877	1561	2448	4003	6257	10265	13962	21659	27422	32971	48438	83867	121576
140	906	1614	2531	4137	6468	10611	14432	22388	28346	34082	50071	86693	1256731
145	936	1667	2614	4272	6679	10957	14903	23118	29270	35194	51703	89520	129770
150	965	1719	2696	4407	6890	11303	15373	23848	30194	36305	53336	92346	133868
155	995	1772	2779	4542	7100	11648	15844	24578	31118	37416	54968	95173	137965
160	1024	1825	2861	4677	7311	11994	16314	25308	32043	38527	56601	97999	142062
165	1054	1877	2944	4812	7522	12340	16785	26038	32967	39638	58233	100825	146159
170	1083	1930	3026	4947	7733	12686	17256	26768	33891	40749	59865	103652	150256
175	1113	1982	3109	5082	7944	13032	17726	27498	34815	41861	61498	106478	154354
180	1143	2035	3191	5217	8155	13378	18197	28228	35739	42972	63130	109305	158451
185	1172	2088	3274	5352	8366	13724	18667	28958	36663	44083	64763	112131	162548
190	1202	2140	3356	5486	8577	14070	19138	29688	37587	45194	66395	114957	166645
195	1231	2193	3439	5621	8787	14416	19608	30418	38512	46305	68028	117784	170743
200	1261	2246	3521	5756	8998	14762	20079	31147	39436	47416	69660	120610	174840
205	1290	2298	3604	5891	9209	15108	20549	31877	40360	48527	71292	123437	178937
210	1320	2351	3686	6026	9420	15454	21020	32607	41284	49639	72925	126263	183034
215	1349	2403	3769	6161	9631	15800	21490	33337	42208	50750	74557	129089	187131
220	1379	2456	3851	6296	9842	16146	21961	34067	43132	51861	76190	131916	191229
225	1408	2509	3934	6431	10053	16492	22431	34797	44057	52972	77822	134742	195326
230	1438	2561	4016	6566	10263	16837	22902	35527	44981	54083	79455	137569	199423
235	1468	2614	4099	6700	10474	17183	23372	36257	45905	55194	81087	140395	203520
240	1497	2667	4181	6835	10685	17529	23843	36987	46829	56306	82719	143221	207618
245	1527	2719	4264	6970	10896	17875	24313	37717	47753	57417	84352	146048	211715
250	1556	2772	4346	7105	11107	18221	24784	38447	48677	58528	85984	148874	215812

# Watts Bronze and Cast Iron Safety Relief Valves

for air, gas and vapors to 250psi at 406°F



**Fig. 41A - ASME Section VIII**

## Applications

Figure 41A is a heavy duty, high capacity safety relief valve for compressors, intercoolers, aftercoolers and receivers, air makeup units, gas burners, pneumatic conveying/elevating equipment, dryers and other pressure vessels and piping, handling air, gases and vapors to 250psi with temperatures to 406°F.

## Features

Unitized bonnet/base design, rugged construction and 2-ring control make the 41A safety relief valve extremely dependable in terms of pop action, seat tightness and repeatability. The single unit cap and lifting lever permit manual valve opening (testing) with low required force on the lever.

## Size/Ratings

Bronze valves are available in twelve sizes ranging from 1/2" x 3/4" to 2 1/2" x 2 1/2", connections are male NPT screwed inlet and female NPT screwed outlet. Cast iron valves are available in sixteen sizes ranging from 1 1/2" x 2 1/2" to 6" x 8". Rating is 250psi at 406°F.

**WATTS Fig. 41A ASME Section VIII Series Valves Saturated Steam Capacities (SCFM @ 90% rating and 10% overpressure)**

Orifice Area (in <sup>2</sup> )	D 0.1188	E 0.2116	F 0.3318	G 0.5424	H 0.8479	J 1.391	K 1.892	L 2.935	M 3.715	N 4.468	P 6.564	Q 11.365	R 16.475
Set Press. psi													
15	63	111	175	285	446	732	996	1545	1956	2351	3455	5981	8671
20	72	128	201	329	514	844	1148	1781	2255	2711	3983	6896	9996
25	82	145	228	373	583	956	1300	2017	2554	3071	4511	7810	11322
30	91	162	255	416	651	1068	1453	2253	2853	3430	5039	8725	12648
35	102	181	284	464	726	1191	1620	2513	3182	3826	5620	9731	14106
40	112	200	313	512	801	1314	1787	2773	3511	4221	6201	10737	15565
45	123	219	343	560	876	1437	1955	3033	3840	4617	6782	11743	17023
50	133	237	372	608	951	1560	2122	3292	4169	5012	7363	12749	18482
55	144	256	402	656	1026	1684	2290	3552	4498	5408	7945	13755	19940
60	154	275	431	704	1101	1807	2457	3812	4826	5803	8526	14761	21398
65	165	294	460	753	1176	1930	2625	4072	5155	6199	9107	15767	22857
70	175	312	490	801	1251	2053	2792	4332	5484	6594	9688	16773	24315
75	186	331	519	849	1326	2176	2960	4592	5813	6990	10269	17779	25773
80	196	350	548	897	1402	2299	3127	4851	6142	7385	10850	18785	27232
85	207	368	578	945	1477	2422	3295	5111	6471	7781	11431	19791	28690
90	217	387	607	993	1552	2545	3462	5371	6800	8176	12012	20797	30149
95	228	406	637	1041	1627	2669	3630	5631	7129	8572	12593	21804	31607
100	238	425	666	1089	1702	2792	3797	5891	7458	8967	13174	22810	33065
105	249	443	695	1137	1777	2915	3965	6150	7787	9363	13755	23816	34524
110	259	462	725	1185	1852	3038	4132	6410	8116	9758	14336	24822	35982
115	270	481	754	1233	1927	3161	4300	6670	8445	10154	14917	25828	37440
120	280	500	783	1281	2002	3284	4467	6930	8774	10549	15498	26834	38899
125	291	518	813	1329	2077	3407	4635	7190	9103	10945	16079	27840	40357
130	302	537	842	1377	2152	3531	4802	7449	9432	11340	16660	28846	41816
135	312	556	872	1425	2227	3654	4970	7709	9761	11736	17241	29852	43274
140	323	575	901	1473	2302	3777	5137	7969	10090	12131	17822	30858	44732
145	333	593	930	1521	2377	3900	5305	8229	10418	12527	18403	31864	46191
150	344	612	960	1569	2452	4023	5472	8489	10747	12922	18984	32870	47649
155	354	631	989	1617	2527	4146	5640	8748	11076	13318	19565	33876	49107
160	365	649	1018	1665	2602	4269	5807	9008	11405	13713	20147	34882	50566
165	375	668	1048	1713	2677	4392	5974	9268	11734	14109	20728	35888	52024
170	386	687	1077	1761	2753	4516	6142	9528	12063	14504	21309	36894	53483
175	396	706	1106	1809	2828	4639	6309	9788	12392	14900	21890	37900	54941
180	407	724	1136	1857	2903	4762	6477	10047	12721	15295	22471	38906	56399
185	417	743	1165	1905	2978	4885	6644	10307	13050	15691	23052	39912	57858
190	428	762	1195	1953	3053	5008	6812	10567	13379	16086	23633	40918	59316
195	438	781	1224	2001	3128	5131	6979	10827	13708	16482	24214	41924	60774
200	449	799	1253	2049	3203	5254	7147	11087	14037	16877	24795	42930	62233
205	459	818	1283	2097	3278	5378	7314	11346	14366	17273	25376	43936	63691
210	470	837	1312	2145	3353	5501	7482	11606	14695	17668	25957	44942	65150
215	480	855	1341	2193	3428	5624	7649	11866	15024	18064	26538	45948	66608
220	491	874	1371	2241	3503	5747	7817	12126	15353	18459	27119	46954	68066
225	501	893	1400	2289	3578	5870	7984	12386	15682	18855	27700	47960	69525
230	512	912	1430	2337	3653	5993	8152	12646	16010	19251	28281	48966	70983
235	522	930	1459	2385	3728	6116	8319	12905	16339	19646	28862	49972	72441
240	533	949	1488	2433	3803	6239	8487	13165	16668	20042	29443	50979	73900
245	543	968	1518	2481	3878	6363	8654	13425	16997	20437	30024	51985	75358
250	554	987	1547	2529	3953	6486	8822	13685	17326	20833	30605	52991	76817

# Watts Bronze Safety Relief Valves

Figure 31/41/41A

## Dimensions/Weights/Materials

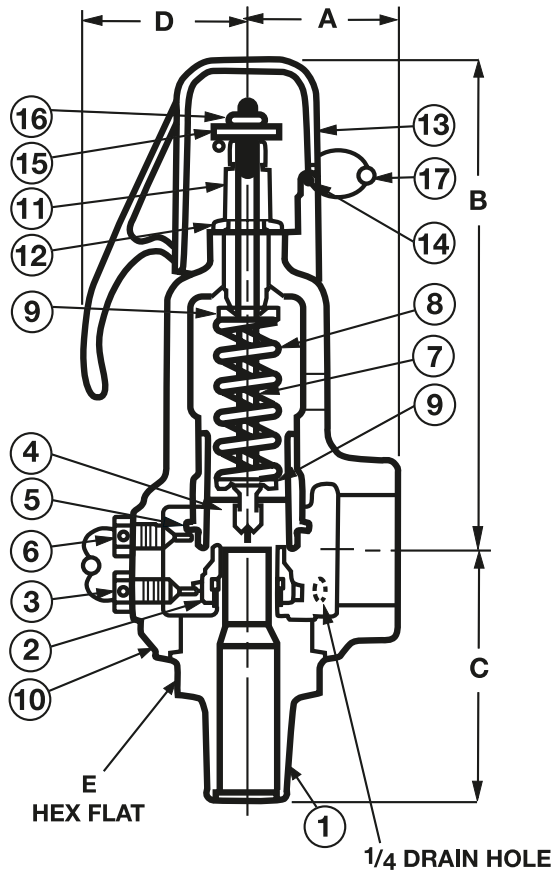

MATERIALS		
Ref. No.	Part Name	Material
1	Base	Bronze
2	Base Ring	Bronze
3	Base Ring Set Screw	Brass
4	Disc	Bronze
5	Guide and Ring	Bronze
6	Guide Ring Set Screw	Brass
7	Spindle	Steel
8	Spring	Plated Steel
9	Spring Washer	Steel
10	Bonnet	Bronze
11	Adjusting Bolt	Brass
12	Adjusting Bolt Locknut	Plated Steel
13	Lifting Cap Zinc	Alloy/Steel
14	Lifting Cap Pin	Plated Steel
15	Spindle Nut	Plated Steel
16	Spindle Nut Locknut	Plated Steel
17	Seal and Wire	Stainless Steel

Valve Size <i>Inlet x Outlet (in.)</i>	Orifice Size	Dimensions (in.)					Weight <i>lb.</i>
		A	B	C	D*	E	
1/2 x 3/4	D	6 <sup>5</sup> / <sub>16</sub>	1 <sup>3</sup> / <sub>8</sub>	2 <sup>1</sup> / <sub>4</sub>	1 <sup>3</sup> / <sub>8</sub>	1 <sup>1</sup> / <sub>8</sub>	2
3/4 x 3/4	D	6 <sup>5</sup> / <sub>16</sub>	1 <sup>3</sup> / <sub>8</sub>	2 <sup>1</sup> / <sub>4</sub>	1 <sup>3</sup> / <sub>8</sub>	1 <sup>1</sup> / <sub>4</sub>	2.25
3/4 x 1	E	7 <sup>1</sup> / <sub>8</sub>	1 <sup>5</sup> / <sub>8</sub>	2 <sup>5</sup> / <sub>16</sub>	1 <sup>3</sup> / <sub>8</sub>	1 <sup>1</sup> / <sub>4</sub>	2.5
1 x 1	E	7 <sup>1</sup> / <sub>8</sub>	1 <sup>5</sup> / <sub>8</sub>	2 <sup>5</sup> / <sub>16</sub>	1 <sup>3</sup> / <sub>8</sub>	1 <sup>1</sup> / <sub>2</sub>	2.75
1 x 1 <sup>1</sup> / <sub>4</sub>	F	9	1 <sup>7</sup> / <sub>8</sub>	2 <sup>13</sup> / <sub>16</sub>	1 <sup>13</sup> / <sub>16</sub>	1 <sup>1</sup> / <sub>2</sub>	4
1 <sup>1</sup> / <sub>4</sub> x 1 <sup>1</sup> / <sub>4</sub>	F	9	1 <sup>7</sup> / <sub>8</sub>	2 <sup>13</sup> / <sub>16</sub>	1 <sup>13</sup> / <sub>16</sub>	1 <sup>3</sup> / <sub>4</sub>	4.25
1 <sup>1</sup> / <sub>4</sub> x 1 <sup>1</sup> / <sub>2</sub>	G	9 <sup>11</sup> / <sub>16</sub>	2 <sup>1</sup> / <sub>8</sub>	3	1 <sup>13</sup> / <sub>16</sub>	1 <sup>7</sup> / <sub>8</sub>	7
1 <sup>1</sup> / <sub>2</sub> x 1 <sup>1</sup> / <sub>2</sub>	G	9 <sup>11</sup> / <sub>16</sub>	2 <sup>1</sup> / <sub>8</sub>	3	1 <sup>13</sup> / <sub>16</sub>	2 <sup>1</sup> / <sub>16</sub>	7.25
1 <sup>1</sup> / <sub>2</sub> x 2	H	12 <sup>1</sup> / <sub>8</sub>	2 <sup>9</sup> / <sub>16</sub>	3 <sup>1</sup> / <sub>2</sub>	2 <sup>3</sup> / <sub>4</sub>	2 <sup>1</sup> / <sub>4</sub>	13.5
2 x 2	H	12 <sup>1</sup> / <sub>8</sub>	2 <sup>9</sup> / <sub>16</sub>	3 <sup>1</sup> / <sub>2</sub>	2 <sup>3</sup> / <sub>4</sub>	2 <sup>9</sup> / <sub>16</sub>	13.75
2 x 2 <sup>1</sup> / <sub>2</sub>	J	13 <sup>5</sup> / <sub>16</sub>	3 <sup>1</sup> / <sub>2</sub>	3 <sup>3</sup> / <sub>4</sub>	2 <sup>3</sup> / <sub>4</sub>	2 <sup>3</sup> / <sub>4</sub>	17.5
2 <sup>1</sup> / <sub>2</sub> x 2 <sup>1</sup> / <sub>2</sub>	J	13 <sup>5</sup> / <sub>16</sub>	3 <sup>1</sup> / <sub>2</sub>	3 <sup>3</sup> / <sub>4</sub>	2 <sup>3</sup> / <sub>4</sub>	3	17.75

\*Add 1/2" to D dimension when lever is pulled out to manually operate the valve.

# Watts Cast Iron Safety Relief Valves

Figure 31/41/41A

## Dimensions/Weights/Materials

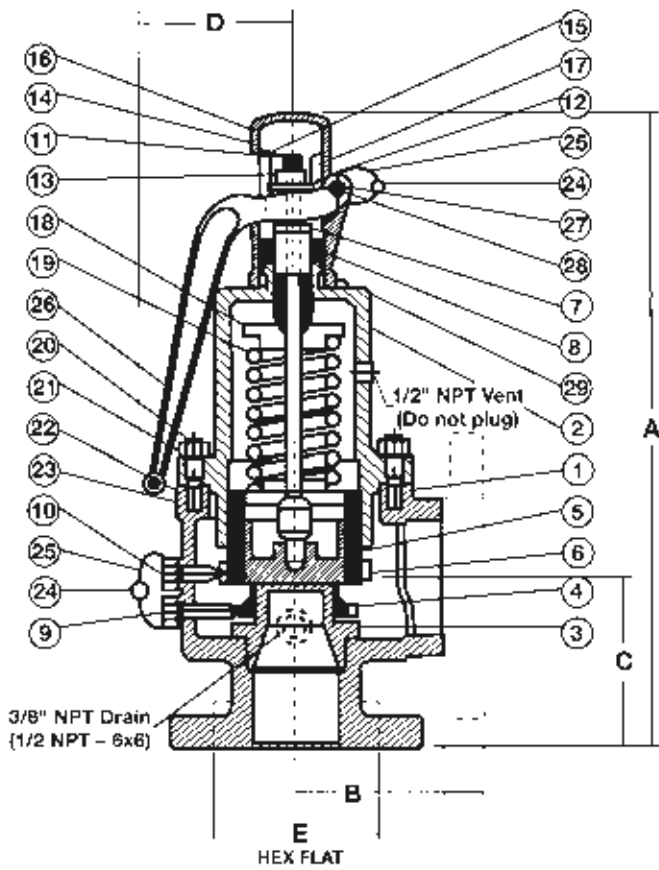

MATERIALS		
Ref. No.	Part Name	Material
1	Body	ASTM A126-B (Grey Iron)
2	Bonnet	ASTM A126-B (Grey Iron)
3	Nozzle	ASTM B26 (Bronze)
4	Nozzle Ring	ASTM B584-844 (Bronze)
5	Disc	ASTM B62 (Bronze)
6	Guide Ring	ASTM B584-844 (Bronze)
7	Adjusting Bolt	ASTM B16 (Brass)
8	Adjusting Bolt Locknut	Steel (Zn Plate)
9	Nozzle Ring Set Screw	Brass
10	Guide Ring Set Screw	Brass
11	Spindle	ASTM A108 Grade 1212
12	Spindle Nut	ASTM A108 Grade 1212
13	Spindle Nut Lock nut	Steel AISI (Zn Plate)
14	Lifting Cap	A126-B Cast Iron
15	Lifting Cap Pins	Steel 1020 (Zn Plate)
16	Pivot Post	Steel AISI
17	Post Pin	Steel AISI 1070 (Zn Plate)
18	Spring Washer	Steel AISI 1212
19	Spring	Steel (Zn Plate)
20	Stud	Steel ASTM A193 B7
21	Stud Nut	Steel ASTM A194 2H
22	Name Plate	SST AISI 304
23	Name Plate Screws	SST 18-8
24	Lead Seal	Lead Commercial
25	Seal Wire	SST AISI 304
26	Lifting Lever	A126-B Cast Iron
27	Clevis Pin	Steel (Zn)
28	Cotter Pin	Steel
29	Liftcap Lockscrew	Steel

Valve Size	Orifice Size	Dimensions (in.)					Weight
		A	B	C	D	E	
<i>Inlet &amp; Outlet (in.)</i>							<i>lb.</i>
1½-250# x 2½ NPT	J	15	3¼	4¼	3	—	24
1½ NPT x 2½ NPT	J	14½	3¼	4¼	3	2¾	20
2-250# x 3 NPT	J,K	15¾	4	4⅝	3½	—	42
2 NPT x 3 NPT	K	15¾	4	4⅝	3½	3⅝	36
2½-250# x 3 NPT	K	15¾	4	4¾	3½	—	45
2½-250# x 4 NPT	L	23	5⅝	5½	6	—	105
2½ NPT x 4 NPT	L	23	5⅝	5½	6	4½	97
3-250# x 3 NPT	K	15¾	4	5	3½	—	48
3-250# x 4 NPT	L,M	23	5⅝	5½	6	—	107
3-NPT# x 4 NPT	M	23⅝	5⅝	5⅝	6	4½	99
4-250# x 6-125#	N,P	28½	7¼	6¾	6	—	212
6-250# x 8-125#	Q,R	45⅞	10	9¼	10½	—	675



# How to Order Watts Safety Relief Valves

You must consider five parameters in order to select the correct valve for your application.

- 1) What is the valve size needed?
  - Nominal pipe size (Inlet x Outlet)
- 2) What is the application?
  - ASME Section IV for Low-Pressure Steam Service and Equipment up to 15psi. Use Series 315/415 or Figure 10. (See pages 10 and 11 for more information.)
  - ASME Section I for Steam Boilers up to 250psi. Use Figure 31.
  - ASME Section VIII for Steam Service and Equipment up to 250psi. Use Figure 41.
  - ASME Section VIII for air, gas, and vapors up to 250psi. Use Figure 41A.
- 3) What is the set pressure in psi?
  - Confirm set pressure with project engineer or boiler plant personnel.
  - Watts valves perform in the 5-250psi range.
- 4) What lbs/hr capacity must the valve relieve?
  - Set pressure and orifice size determine valve capacity.
  - Orifice size is designated by the letter D through R and is determined by ASME standards. (Use the saturated steam capacity charts provided in this guide to determine the orifice size.)
- 5) What end connections are required?
  - NPT x NPT
  - Flange x NPT
  - Flange x Flange

## Ordering Information

Figure 31/41/41A Bronze Safety Relief Valves



Ordering Code	Valve Size			Pipe Connection
	Inlet	Orifice	Outlet	NPT X Outlet
0390700	1/2"	D	3/4"	NPT x NPT
0390701	3/4"	D	3/4"	NPT x NPT
0390702	3/4"	E	1"	NPT x NPT
0390703	1"	E	1"	NPT x NPT
0390704	1"	F	1 1/4"	NPT x NPT
0390705	1 1/4"	F	1 1/4"	NPT x NPT
0390706	1 1/4"	G	1 1/2"	NPT x NPT
0390707	1 1/2"	G	1 1/2"	NPT x NPT
0390708	1 1/2"	H	2"	NPT x NPT
0390709	2"	H	2"	NPT x NPT
0390710	2"	J	2 1/2"	NPT x NPT
0390711	2 1/2"	J	2 1/2"	NPT x NPT

Figure 31/41/41A Cast Iron Safety Relief Valves



Ordering Code	Valve Size			Pipe Connection
	Inlet	Orifice	Outlet	NPT X Outlet
0390712	1 1/2"	J	2 1/2"	250 FLG x NPT
0390713	1 1/2"	J	2 1/2"	NPT x NPT
0390714	2"	J	3"	250 FLG x NPT
0390715	2"	K	3"	250 FLG x NPT
0390716	2"	K	3"	NPT x NPT
0390717	2 1/2"	K	3"	250 FLG x NPT
0390718	2 1/2"	L	4"	250 FLG x NPT
0390719	2 1/2"	L	4"	NPT x NPT
0390720	3"	K	3"	250 FLG x NPT
0390721	3"	L	4"	250 FLG x NPT
0390722	3"	M	4"	250 FLG x NPT
0390723	3"	M	4"	NPT x NPT
0390724	4"	N	6"	250 FLG/125 FLG
0390725	4"	P	6"	250 FLG/125 FLG
0390726	6"	Q	8"	250 FLG/125 FLG
0390727	6"	R	8"	250 FLG/125 FLG

# Watts Bronze Safety Relief Valves

for steam heating boilers with operating pressures to 15psi

## Series 315/415 ASME Section IV

### Applications

Series 315/415 are ASME Section IV safety relief valves designed for industrial and commercial low-pressure steam equipment.

Standard pressure settings for saturated steam service are 5 thru 15psi.

### Features

Series 315 valves feature a bronze body and stainless steel spring. A top guided stem and non-stick Teflon® disc-to-metal seat assure positive shutoff. These valves are also available in lower settings, such as 8psi for pressure cooker and steam cleaning equipment requirements.

Series 415 valves feature a forged brass body for the 3/4" size and a bronze body for the 1", 1 1/4", and 1 1/2" valves. All sizes of the Series 415 relief valves feature a stainless steel spring for accurate set point relieving. Series 415 valves feature tight shutoff, sharp popping and closing action with a high degree of repeatability. The simple design means dependability and low cost.



Series 315

Series 315 and 415 are capacity certified by the National Board at 15psi in accordance with ASME Boiler and Pressure Vessel Code Section IV.

### Size/Ratings

Series 315/415 are available in 4 sizes ranging from 3/4" x 3/4" to 1 1/2" x 2". Connections are male NPT screwed inlet and female NPT screwed outlet. The body is rated at 15psi saturated steam temperature 250°F.

### Dimensions/Weights

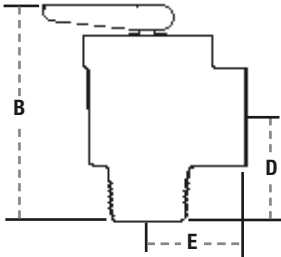

Model No.	Ordering Code*	Size (in.)	ASME Steam Discharge Capacity lbs./hr. @ 15psi	Dimensions						Weight	
				B		D		E		lbs.	kg.
				in.	mm	in.	mm	in.	mm		
315-M1	0342615	3/4 x 3/4	375	2 11/16	68	1 3/8	35	1 1/4	32	.55	.24
415-M1	0346045	3/4 x 3/4	450	2 13/16	71	1 5/16	33	1 1/4	32	.70	.31
415-M1	0346044	1 x 1	643	3 3/8	78	1 11/16	43	1 5/8	41	.91	.41
415	0364195	1 1/4 x 1 1/2	1265	4 3/4	121	2 3/8	60	2 1/8	54	2.00	.91
415	0364200	1 1/2 x 2	1860	5 7/16	138	2 5/8	67	2 3/16	59	3.00	1.36

\*Ordering codes are for standard 15psi settings. Consult factory for ordering codes for non-standard pressure settings.

# Watts Cast Iron Safety Relief Valves

for steam heating with operating pressure to 15psi

**Fig. 10 - ASME Section IV**

## Applications

Figure 10 valves are ASME Section IV safety relief valves designed for industrial and commercial low pressure steam heating boilers and associated equipment. Standard pressure settings for saturated steam service are 5 thru 15psi.



## Features

The Figure 10 valve features tight shutoff, sharp popping and closing action and a high degree of repeatability. The valve inlet and body are one integral casting assuring proper alignment of disc, seat and spindle for smooth action. The disc is located by a disc guide which in turn is held in place by a zinc plated wave spring. The entire assembly is contained by a combination bonnet/compression screw. The simplicity of the design means dependability and low cost.

## Size/Ratings

Figure 10 valves are available in seven sizes ranging from 3/4" x 1" to 3" x 3". Connections are male NPT screwed inlet and female NPT screwed outlet. The cast iron body is rated at 15psi at saturated steam temperature 250°F.

## Dimensions/Weights

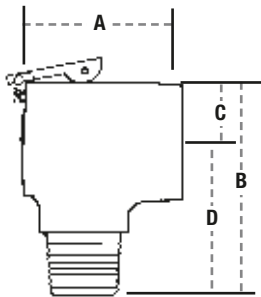

Model No.	Ordering Code	Size (DN)		Dimensions								Weight	
		in.	mm	A		B		C		D		lbs.	kg.
				in.	mm	in.	mm	in.	mm	in.	mm		
Fig. 10	0215998†	3/4 x 1	20 x 25	2 1/4	57	3 1/16	84	1 3/16	30	2 1/8	54	1	5
Fig. 10	0216006*	1 x 1 1/4	25 x 32	3	76	4	102	1 3/8	35	2 5/8	67	2	.9
Fig. 10	0216002*	1 1/4 x 1 1/2	32 x 40	3 1/4	83	5	127	1 5/16	49	3	76	3	1.4
Fig. 10	0215997†	1 1/2 x 2	40 x 50	3 3/8	86	5 1/8	130	2	51	3 7/16	81	4	1.8
Fig. 10	0215994‡	2 x 2 1/2	50 x 65	4 1/2	114	6 1/16	171	2 1/16	68	4	102	8	3.6
Fig. 10	0216018Δ	2 1/2 x 2 1/2	65 x 65	5 1/4	133	8 3/8	213	4	102	4 3/8	111	14	6.4
Fig. 10	0215995‡	3 x 3	80 x 80	6	150	9 1/2	241	4 3/8	111	5 1/8	130	22	10

Set At: †(12psi/82.7 kPa), \*(10psi/68.9 kPa), Δ(8psi/55.2 kPa), ‡(5psi/34.5 kPa)

WATTS Fig. 10 ASME Section IV Series Valves									
Saturated Steam Capacities (lbs./hr. @ 90% rating and 33 1/3% Overpressure)									
Model	Set Pressure	Inlet x Outlet (in.)							
		psi	kPa	3/4 x 1	1 x 1 1/4	1 1/4 x 1 1/2	1 1/2 x 2	2 x 2 1/2	2 1/2 x 2 1/2
Fig. 10	5*	34	230	409	649	924	1637	2557	3698
Fig. 10	10*	69	318	565	882	1276	2260	3530	5106
Fig. 10	15	103	394	700	1093	1581	2801	4375	6328

\* Capacities for 5 and 10psi are not certified by ASME National Board.

# For Technical Assistance Call Your Authorized Watts Agent.

			Telephone #	Fax #
	<b>HEADQUARTERS:</b> Watts Regulator Company	815 Chestnut St., North Andover, MA 01845-6098 U.S.A.	978 688-1811	978 794-1848
<b>North East</b>	Edwards, Platt & Deely, Inc.	271 Royal Ave., Hawthorne, NJ 07506	973 427-2898	973 427-4246
	Edwards, Platt & Deely, Inc.	368 Wyandanch Ave., North Babylon, NY 11703	631 253-0600	631 253-0303
	W. P. Haney Co., Inc.	51 Norfolk Ave., South Easton, MA 02375	508 238-2030	508 238-8353
<b>Mid Atlantic</b>	J. B. O'Connor Company, Inc.	P.O. Box 12927, Pittsburgh, PA 15241	724 745-5300	724 745-7420
	RMI	Glenfield Bus. Ctr., 2535 Mechanicsville Tpk., Richmond, VA 23223	804 643-7355	804 643-7380
	The Joyce Agency, Inc.	8442 Alban Rd., Springfield, VA 22150	703 866-3111	703 866-2332
	Vernon Bitzer Associates, Inc.	980 Thomas Drive, Warminster, PA 18974	215 443-7500	215 443-7573
	WMS Sales, Inc. (Main office)	9580 County Rd., Clarence Center, NY 14032	716 741-9575	716 741-4810
<b>South East</b>	Billingsley & Associates, Inc.	2728 Crestview Ave., Kenner, LA 70062-4829	504 602-8100	504 602-8106
	Billingsley & Associates, Inc.	478 Cheyenne Lane, Madison, MS 39110	601 856-7565	601 856-8390
	Francisco J. Ortiz & Co., Inc.	Charlyn Industrial Pk., Road 190 KM1.9 - Lot #8, Carolina, Puerto Rico 00983	787 769-0085	787 750-5120
	Mid-America Marketing, Inc.	203 Industrial Drive, Birmingham, AL 35211	205 879-3469	205 870-5027
	Mid-America Marketing, Inc.	1364 Foster Avenue, Nashville, TN 37210	615 259-9944	615 259-5111
	Mid-America Marketing, Inc.	5466 Old Hwy. 78, Memphis, TN 38118	901 795-0045	901 795-0394
	Smith & Stevenson Co., Inc.	4935 Chastain Ave., Charlotte, NC 28217	704 525-3388	704 525-6749
	Harry Warren, Inc.	1400 North Orange Blossom Trail, Orlando, FL 32804	407 841-9237	407 841-9246
	Watts Georgia	2861-B Bankers Industrial Drive, Atlanta, GA 30360	770 209-3310	770 447-4583
	<b>North Central</b>	Aspinall Associates, Inc.	6840 Hillsdale Court, Indianapolis, IN 46250	317 849-5757
Dave Watson Associates		1325 West Beecher, Adrian, MI 49221	517 263-8988	517 263-2328
Disney McLane & Associates		428 McGregor Ave., Cincinnati, OH 45206	800 542-1682	877 476-1682
BWA Company		17610 S. Waterloo Rd., Cleveland, OH 44119	216 486-1010	216 486-2860
Mid-Continent Marketing Services Ltd.		1724 Armitage Ct., Addison, IL 60101	630 953-1211	630 953-1067
Soderholm & Associates, Inc.		7150 143rd Ave. N.W., Anoka, MN 55303	763 427-9635	763 427-5665
	Stickler & Associates	333 North 121 St., Milwaukee, WI 53226	414 771-0400	414 771-3607
<b>South Central</b>	Hugh M. Cunningham, Inc.	13755 Benchmark, Dallas, TX 75234	972 888-3808	972 888-3838
	Mack McClain & Associates	4407 Meramec Bottom, Suite G, St. Louis, MO 63129	314 894-8188	314 894-8388
	Mack McClain & Associates, Inc.	1450 NE 69th Place, Ste. 56 Ankeny, IA 50021	515 288-0184	515 288-5049
	Mack McClain & Associates, Inc.	15090 West 116th St., Olathe, KS 66062	913 339-6677	913 339-9518
	OK! Sales, Inc.	214-A NE 12th., Moore, OK 73160	405 794-5200	405 794-5250
	Phoenix Marketing, Ltd.	2416 Candelaria N.E., Albuquerque, NM 87107	505 883-7100	505 883-7101
<b>Western</b>	Delco Sales, Inc.	1930 Raymer Ave., Fullerton, CA 92833	714 888-2444	714 888-2448
	Delco Sales, Inc.	111 Sand Island Access Rd., Unit I-10, Honolulu, HI 96819	808 842-7900	808 842-9625
	Fanning & Associates, Inc.	6765 Franklin St., Denver, CO 80229-7111	303 289-4191	303 286-9069
	Hollabaugh Brothers & Associates	6915 South 194th St., Kent, WA 98032	253 867-5040	253 867-5055
	Hollabaugh Brothers & Associates	3028 S.E. 17th Ave., Portland, OR 97202	503 238-0313	503 235-2824
	P I R Sales, Inc.	3050 North San Marcos Place, Chandler, AZ 85225	480 892-6000	480 892-6096
	Preferred Sales	31177 Wiegman Road, Hayward, CA 94544	510 487-9755	510 476-1595
	R. E. Fitzpatrick Sales, Inc.	4109 West Nike Dr. (8250 South), West Jordan, UT 84088	801 282-0700	801 282-0600
<b>Canada</b>	Watts Industries (Canada) Inc. (Watts Regulator Co. Division)	5435 North Service Road, Burlington, Ontario L7L 5H7	905 332-4090	905 332-7068
	Con-Cur West Marketing, Inc.	71B Clipper Street, Coquitlam, British Columbia V3K 6X2	604 540-5088	604 540-5084
	D.C. Sales Corporation Inc.	#10-6130 4th St. S.E., Calgary, Alberta T2H 2B6	403 253-6808	403 259-8331
	D.C. Sales Corporation Inc.	11420 142 Street, Edmonton, Alberta T5M 1V1	780 496-9495	780 496-9621
	GTA Sales Team.	Greater Toronto Area	888 208-8927	888 479-2887
	Hydro-Mechanical Sales, Ltd.	3700 Joseph Howe Drive, Suite 1, Halifax, Nova Scotia B3L 4H7	902 443-2274	902 443-2275
	Hydro-Mechanical Sales, Ltd.	P.O. Box 1445 (Mailing), 297 Collishaw St., Suite 7 (shipping) Moncton, New Brunswick E1C 9R2	506 859-1107	506 859-2424
	J.D.S. Sales Ltd.	4 Lancaster Street, St. John's, Newfoundland A1A 5P7	709 579-5771	709 579-1558
	Le Groupe B.G.T., Inc.	23 du Buisson, Pont Rouge, Quebec G3H 1X9	418 873-2500	418 873-2505
	Le Groupe B.G.T., Inc.	86 des Entreprises #208, Boisbriand, Quebec J7G 2T3	450 434-9010	450 434-9848
	Mar-Win Agencies, Ltd.	1333 Clifton St., Winnipeg, Manitoba R3E 2V1	204 775-8194	204 786-8016
	Northern Mechanical Sales	P.O. Box 280 (mailing) 163 Pine St. (shipping), Garson, Ontario P3L 1S6	705 693-2715	705 693-4394
	Palsler Enterprises, Ltd.	P.O. Box 28136 (mailing), 1885 Blue Heron Dr., #4, London, Ontario N6H 5L9	519 471-9382	519 471-1049
RAM Mechanical Marketing Inc.	1401 St. John Street, Regina, Saskatchewan S4R 1S5	306 525-1986	306 525-0809	
RAM Mechanical Marketing Inc.	510 Ave M South, Saskatoon, Saskatchewan S7M 2K9	306 244-6622	306 244-0807	
Walmart Mechanical Sales	24 Gurdwara Rd., Nepean, Ontario K2E 8B5	613 225-9774	613 225-0673	
0625	<b>EXPORT Hdqtrs.:</b> Watts Regulator Co.	815 Chestnut St., North Andover, MA 01845-6098 U.S.A.	978 688-1811	978 794-1848

