

Electric Floor Heating Solutions



- Custom TapeMat®
- TapeMat®
- ShowerMat™
- UnderFloor™ Mat
- WarmWire®
- SlabHeat®
- SunStat® Thermostats

2015 Catalog

Come Home to Comfort™

Enhance any space with an electric floor heating system that's easy to use & install. From kitchens & bathrooms, to laundry rooms or basements, SunTouch® makes it easy to add warmth to the surfaces that surround you.

Why Choose SunTouch?

With SunTouch, you can have a luxury floor heating system without the luxury price tag.

- A SunTouch system costs only pennies a day to operate
- Flexible solutions for above or below the floor, in both new & retrofit construction
- Proven reputation with thousands of successful installations across North America
- World-class design, manufacturing & technical support
- Assembled in USA & backed by a 25-year warranty



suntouch.com



New Custom TapeMat® 4

- Order mat to your exact floor plan
- Simply unroll to fit the space
- No cuts or turns required



TapeMat® 5

- Edged with easy-to-install double-sided tape
- Open-weave mesh allows mortar to easily bond with underlying material
- Approved for shower installation

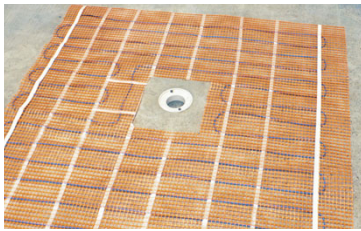

New ShowerMat™ 7

- Simple solution for built-in shower floor heating
- Standard 36" x 60" & 48" x 48" sizes
- 4" center drain cut out



UnderFloor™ Mat 8

- Installs between floor joists to warm the floor above
- No need to renovate the space
- Works under any type of floor covering including naildown hard wood

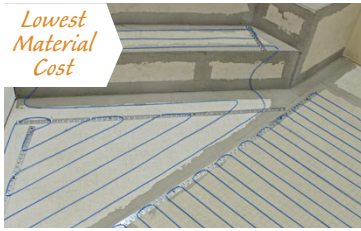

WarmWire® 9

- Can be installed under tile or stone in wet applications
- Fits rooms of all shapes & sizes
- Low profile



SlabHeat® 12

- Enough heat for either floor warming or space heating
- Installs over an existing slab in a "slab cap" or in a new slab
- Great for small, low-heat areas like shops or garages



SunStat® Thermostats & Relays 13

- Model options include energy saving schedules & touchscreen operation
- Dual voltage for 120 or 240V - built in GFCI
- Air & floor temperature sensing



Accessories 14

- Common tools for electric floor heating installation

ProMelt® Mats, Cables®, Controls, & Accessories are available through a separate catalog. Visit suntouch.com or contact your local SunTouch® representative for more information.

The fast-lane option for electric floor heating

- Order mat to fit your exact floor plan, no cuts or turns required
- Simply unroll then apply thin-set or self-leveler
- Custom made to match curves, angles, & cut-outs
- UL listed at 12 Watts/square foot

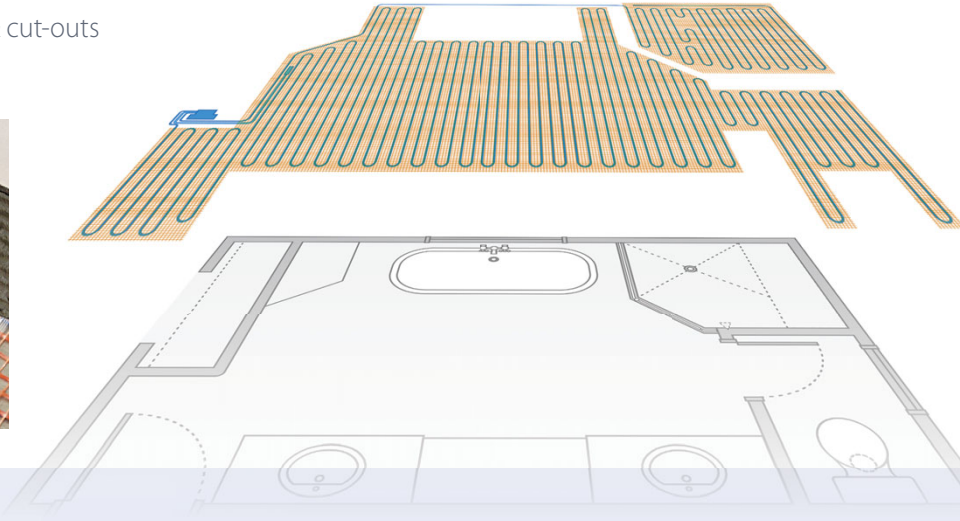

How to Order Custom TapeMat

1. Send in a complete drawing to designs@wattswater.com or call our design team toll-free at 1-888-432-8932 for assistance.
2. Drawing must include the following:
 - Complete, accurate dimensions of the area to be heated. Include all wall dimensions from start to finish around the perimeter of the room
 - Thermostat location
 - Dimensions & locations of any obstructions in the heated area (vents, plug-ins, plumbing, cabinets, steps, etc.)
3. A design showing the Custom TapeMat layout will be faxed back for customer approval.
4. Once the design is approved, please send SunTouch a purchase order, including:
 - Custom TapeMat order number
 - Custom TapeMat project number
 - Customer's approved signature on the design drawing
5. Mats will ship within 3 business days after receipt of purchase order with the customer approved, signed drawing.

120 VAC Custom TapeMats

Ft ²	Order #	Model #	Amps
10	81016649	C12120010ST	1.0
15	81016650	C12120015ST	1.5
20	81016651	C12120020ST	2.0
25	81016652	C12120025ST	2.5
30	81016653	C12120030ST	3.0
35	81016654	C12120035ST	3.5
40	81016590	C12120040ST	4.0
45	81016655	C12120045ST	4.5
50	81016656	C12120050ST	5.0
60	81016565	C12120060ST	6.0
70	81016657	C12120070ST	7.0
80	81016658	C12120080ST	8.0

240 VAC Custom TapeMats

Ft ²	Order #	Model #	Amps
20	81016659	C12240020ST	1.0
30	81016660	C12240030ST	1.5
40	81016661	C12240040ST	2.0
50	81016662	C12240050ST	2.5
60	81016663	C12240060ST	3.0
70	81016664	C12240070ST	3.5
80	81016665	C12240080ST	4.0
90	81016666	C12240090ST	4.5
100	81016667	C12240100ST	5.0
120	81016668	C12240120ST	6.0
140	81016669	C12240140ST	7.0
160	81016670	C12240160ST	8.0

Open weave design for easy, 1-step mortar installation

TapeMat®



- 1-step application with thin-set or self-leveler
- 1/8" thickness added to a typical tile installation
- Available in 2 & 3 foot roll widths
- Simple to adjust for curves, angles, & cut-outs
- Double-sided tape adheres to subfloor for faster layouts
- UL listed at 12 Watts/square foot



How much SunTouch® TapeMat® do I order?

- Calculate the total wall-to-wall square footage of the room
- Subtract the square footage of all built-ins (closets, tub, toilet, cabinets)
- Multiply the result by .9 and round down to the nearest 5 ft²
- Select TapeMat to match roll width, voltage & square footage

TapeMat is available in 2' & 3' roll widths with 120 VAC or 240 VAC Power

120 VAC TapeMat

Mat Size (L x W)	Ft ²	Order#	Model#	Amps	
2' Wide	5' x 2'	10	81002183	12000524ST	1.0
	7' 6" x 2'	15	81007233	12000724ST	1.5
	10' x 2'	20	81002197	12001024ST	2.0
	12' 6" x 2'	25	81007234	12001224ST	2.5
	15' x 2'	30	81002208	12001524ST	3.0
	17' 6" x 2'	35	81007235	12001724ST	3.5
	20' x 2'	40	81002217	12002024ST	4.0
	22' 6" x 2'	45	81007236	12002224ST	4.5
	25' x 2'	50	81002226	12002524ST	5.0
	30' x 2'	60	81002234	12003024ST	6.0
	35' x 2'	70	81002240	12003524ST	7.0
	40' x 2'	80	81002246	12004024ST	8.0
	45' x 2'	90	81018554	12004524ST	9.0
	50' x 2'	100	81018555	12005024ST	10

240 VAC TapeMat

Mat Size (L x W)	Ft ²	Order#	Model#	Amps	
2' Wide	10' x 2'	20	81002265	24001024ST	1.0
	15' x 2'	30	81002269	24001524ST	1.5
	20' x 2'	40	81002274	24002024ST	2.0
	25' x 2'	50	81002279	24002524ST	2.5
	30' x 2'	60	81002284	24003024ST	3.0
	35' x 2'	70	81002288	24003524ST	3.5
	40' x 2'	80	81002293	24004024ST	4.0
	45' x 2'	90	81002407	24004524ST	4.5
	50' x 2'	100	81002410	24005024ST	5.0
	60' x 2'	120	81002415	24006024ST	6.0
	70' x 2'	140	81002419	24007024ST	7.0
	80' x 2'	160	81002422	24008024ST	8.0
	90' x 2'	180	81018556	24009024ST	9.0
	100' x 2'	200	81018557	24010024ST	10

Mat Size (L x W)	Ft ²	Order#	Model#	Amps	
3' Wide	5' x 3'	15	81002184	12000536ST	1.5
	6' 8" x 3'	20	81002188	12000636ST	2.0
	8' 4" x 3'	25	81002194	12000836ST	2.5
	10' x 3'	30	81002200	12001036ST	3.0
	15' x 3'	45	81002209	12001536ST	4.5
	20' x 3'	60	81002220	12002036ST	6.0

Mat Size (L x W)	Ft ²	Order#	Model#	Amps	
3' Wide	10' x 3'	30	81002266	24001036ST	1.5
	13' 4" x 3'	40	81002268	24001336ST	2.0
	16' 8" x 3'	50	81002272	24001636ST	2.5
	20' x 3'	60	81002277	24002036ST	3.0
	30' x 3'	90	81002286	24003036ST	4.5
	40' x 3'	120	81002406	24004036ST	6.0

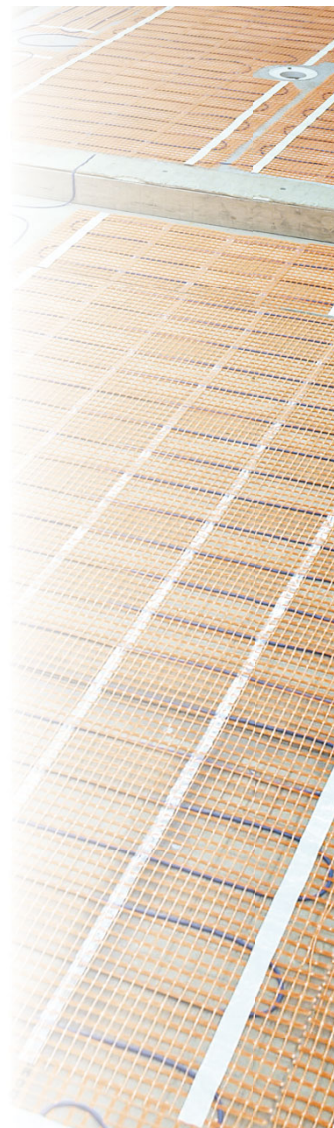

A winning combination

TapeMat® Kits include everything needed for a quick & simple floor warming installation

TapeMat Kits Include:

- 2' wide TapeMat
- SunStat® Pro II Thermostat
- Extra Double-sided Tape
- LoudMouth™ Installation Monitor
- Installation Manual

TapeMat Kits are now available with our new SunStat View touchscreen thermostat. Contact your customer service representative for ordering information.

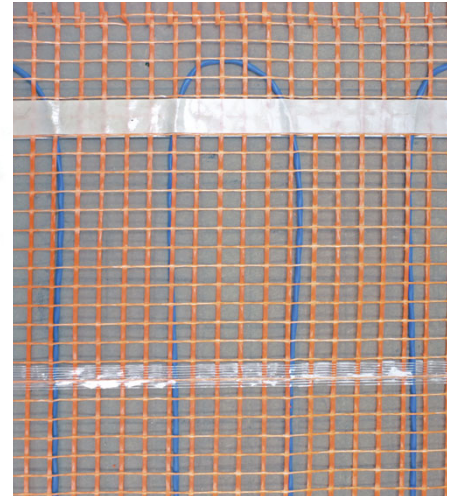

TapeMat Kits are available for a full range of room sizes

120 VAC TapeMat Kits

Ft ²	Quantity & Size of Mats	Order#	Model#	Amps
10	(1) 2' x 5'	81009684	12000524-KIT	1.0
15	(1) 2' x 7.5'	81009685	12000724-KIT	1.5
20	(1) 2' x 10'	81009686	12001024-KIT	2.0
25	(1) 2' x 12.5'	81009687	12001224-KIT	2.5
30	(1) 2' x 15'	81009688	12001524-KIT	3.0
35	(1) 2' x 17.5'	81009689	12001724-KIT	3.5
40	(1) 2' x 20'	81009690	12002024-KIT	4.0
45	(1) 2' x 22.5'	81009691	12002224-KIT	4.5
50	(1) 2' x 25'	81009692	12002524-KIT	5.0
60	(1) 2' x 30'	81009693	12003024-KIT	6.0
70	(1) 2' x 35'	81009694	12003524-KIT	7.0
80	(1) 2' x 40'	81009695	12004024-KIT	8.0
90	(1) 2' x 45'	81010512	12004524-KIT	9.0
100	(1) 2' x 50'	81010513	12005024-KIT	10.0
110	(1) 2' x 25' & (1) 2' x 30'	81010514	12005524-KIT	11.0
120	(2) 2' x 30'	81010515	12006024-KIT	12.0
130	(1) 2' x 30' & (1) 2' x 35'	81010516	12006524-KIT	13.0
140	(2) 2' x 35'	81010517	12007024-KIT	14.0
150	(1) 2' x 35' & (1) 2' x 40'	81010518	12007524-KIT	15.0

240 VAC TapeMat Kits

Ft ²	Quantity & Size of Mats	Order#	Model#	Amps
160	(1) 2' x 80'	81012716	24008024-KIT	8.0
170	(1) 2' x 40' & (1) 2' x 45'	81012717	24008524-KIT	8.5
180	(1) 2' x 90'	81012718	24009024-KIT	9.0
190	(1) 2' x 45' & (1) 2' x 50'	81012719	24009524-KIT	9.5
200	(1) 2' x 100'	81012720	24010024-KIT	10.0
220	(1) 2' x 50' & (1) 2' x 60'	81012721	24011024-KIT	11.0
240	(2) 2' x 60'	81012722	24012024-KIT	12.0
260	(1) 2' x 60' & (1) 2' x 70'	81012723	24013024-KIT	13.0
280	(2) 2' x 70'	81012724	24014024-KIT	14.0
300	(1) 2' x 70' & (1) 2' x 80'	81012725	24015024-KIT	15.0

Add a touch of luxury to your tile shower installations

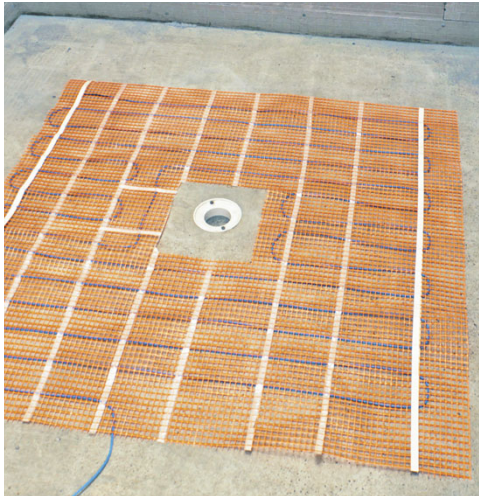

- Available in two sizes to fit standard shower bases
- Custom sizes available by ordering as a Custom TapeMat
- Open-weave mesh allows mortar to easily bond with underlying material
- Low, thin profile

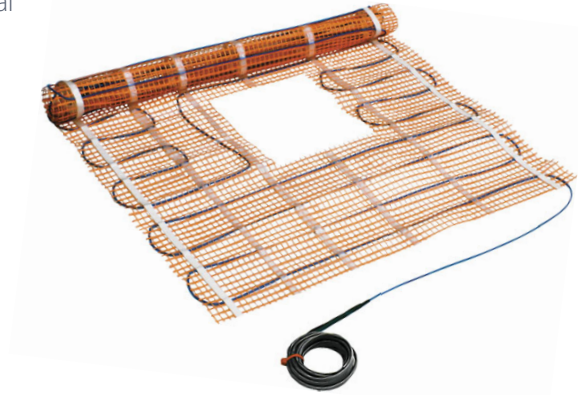

ShowerMat™

Tile & stone feel warm & soothing when installed over an operating ShowerMat. With this simple addition, you can improve comfort & floor surface drying times. ShowerMats are installed in thinset mortar above the shower pan liner. They can be individually controlled, or operated by the same control as other floor heated areas of the bathroom. ShowerMats make it easy to install a separate heating system in the shower.

- Operated by any SunStat thermostat
- Secure to liner with glue gun or double-sided tape
- 4" center drain cut out
- 10' power lead for installation outside of the shower
- 25 year limited warranty

120 VAC ShowerMat

Shower base size	Actual mat size	Order#	Model#	Amps
36" x 60"	28" x 52"	81017075	C12120010ST-S3660	1.0
48" x 48"	39" x 39"	81017076	C12120010ST-S4848	1.0

Other sizes are available by special order

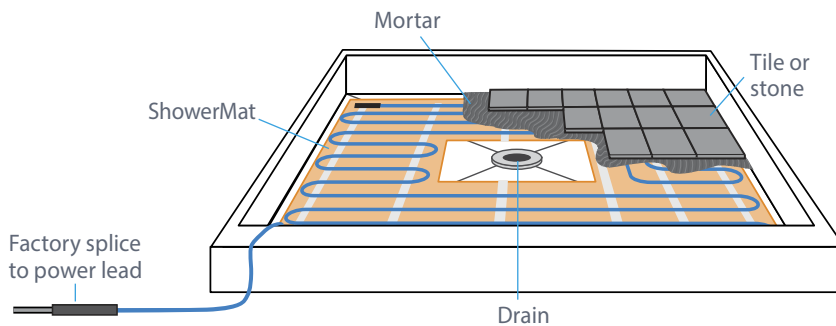

Enjoy heated floors without replacing flooring

- No need to replace flooring - installs between floor joists to warm the floor above
- Works under any type of flooring including nail down hardwood
- Up to 15°F warmer with hard-surface flooring
- Between 6°F and 10°F warmer with carpet



UnderFloor™ Mats

These easy to install mats come in two widths for common joist spacing. For the best performance, follow the installation manual recommendations for insulating below mats.

120 VAC UnderFloor Mat

	Mat Size (L x W)	Order#	Model#	Amps
12" Wide	5' 6" x 12"	81007125	1200512U2ST	0.5
	8' x 12"	81007126	1200812U2ST	0.7
	10' 6" x 12"	81007127	1201012U2ST	0.9
	13' x 12"	81007128	1201312U2ST	1.1
	16' x 12"	81007129	1201312U2ST	1.3
16" Wide	4' x 16"	81006826	1200416U2ST	0.4
	6' x 16"	81006827	1200616U2ST	0.7
	8' x 16"	81006828	1200816U2ST	0.9
	9' 6" x 16"	81006829	1200916U2ST	1.1
	12' x 16"	81006830	1201216U2ST	1.3
	14' x 16"	81006831	1201416U2ST	1.6
	16' x 16"	81006832	1201616U2ST	1.8
	18' x 16"	81006833	1201816U2ST	2.0
	19' 6" x 16"	81006834	1201916U2ST	2.2

240 VAC UnderFloor Mat

	Mat Size (L x W)	Order#	Model#	Amps
12" Wide	10' 6" x 12"	81007134	2401012U2ST	0.4
	16' x 12"	81007135	2401612U2ST	0.7
16" Wide	8' x 16"	81006835	2400816U2ST	0.4
	12' x 16"	81006836	2401216U2ST	0.7
	16' x 16"	81006837	2401616U2ST	0.9
	19' 6" x 16"	81006838	2401916U2ST	1.1

The flexibility to fit any floor plan at a cost effective price

WarmWire®

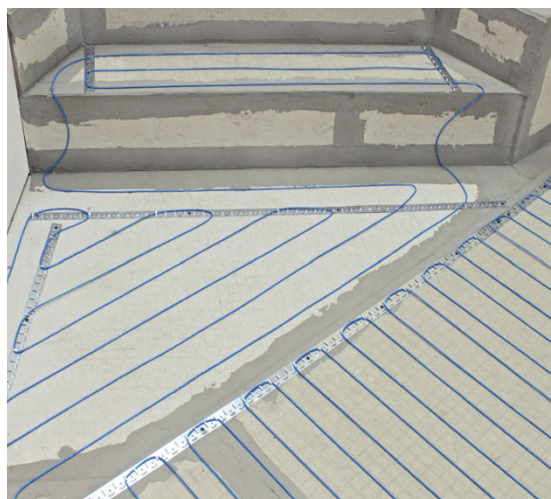

- Complete design freedom
- Wire is easily secured at 2.5", 3" or 3.5" spacing with CableStrap™
- Approved for shower installation where permitted by the local authority having jurisdiction (AHJ)
- Low profile



WarmWire® Spools

WarmWire coverage depends on the selected wire spacing.

- 2.5" spacing is recommended for high heat loss areas like sunrooms or basement rec rooms.
- 3" spacing is recommended for kitchens, bathrooms, & living rooms over wood-framed subfloors.
- 3.5" spacing may be used in lower heat loss areas such as hallways.



120 VAC WarmWire

Coverage (ft ²)			Order#	Model#	Length	Amps
2.5" o.c. (14.4 W/ft ²)	3" o.c. (12 W/ft ²)	3.5" o.c. (10.3 W/ft ²)				
8	10	12	81018061	120010WD-BST	39'	1.0
13	15	18	81018062	120015WD-BST	59'	1.5
17	20	24	81018063	120020WD-BST	78'	2.0
21	25	30	81018064	120025WD-BST	98'	2.5
25	30	36	81018065	120030WD-BST	117'	3.0
29	35	42	81018066	120035WD-BST	137'	3.5
34	40	48	81018067	120040WD-BST	157'	4.0
38	45	54	81018068	120045WD-BST	176'	4.5
42	50	60	81018069	120050WD-BST	196'	5.0
51	60	72	81018070	120060WD-BST	235'	6.0
59	70	84	81018071	120070WD-BST	274'	7.0
67	80	96	81018072	120080WD-BST	313'	8.0
76	90	108	81018073	120090WD-BST	352'	9.0
84	100	120	81018074	120100WD-BST	391'	10.0

Standard spacing

240 VAC WarmWire

Coverage (ft ²)			Order#	Model#	Length	Amps
2.5" o.c. (14.4 W/ft ²)	3" o.c. (12 W/ft ²)	3.5" o.c. (10.3 W/ft ²)				
17	20	24	81018075	240020WD-BST	78'	1.0
25	30	36	81018076	240030WD-BST	117'	1.5
34	40	48	81018077	240040WD-BST	157'	2.0
42	50	60	81018078	240050WD-BST	196'	2.5
51	60	72	81018079	240060WD-BST	235'	3.0
59	70	84	81018080	240070WD-BST	274'	3.5
67	80	96	81018081	240080WD-BST	313'	4.0
76	90	108	81018082	240090WD-BST	352'	4.5
84	100	120	81018083	240100WD-BST	391'	5.0
101	120	144	81018084	240120WD-BST	470'	6.0
118	140	168	81018085	240140WD-BST	548'	7.0
135	160	192	81018086	240160WD-BST	626'	8.0
151	180	216	81018087	240180WD-BST	704'	9.0
168	200	240	81018088	240200WD-BST	783'	10.0

Standard spacing

Select a Kit for easy ordering

WarmWire® Kits make it easy to select products to match your installation.

WarmWire Kits include:

- WarmWire Cable(s)
- SunStat® Pro II Thermostat
- CableStrap™
- LoudMouth® Installation Monitor
- Double-sided tape
- Installation Manual

WarmWire Kits are now available with our new SunStat View touchscreen thermostat. Contact your customer service representative for ordering information.



120 VAC WarmWire Kits

Coverage (ft ²)			Quantity & Size of Cables	Order#	Model#	Amps
2.5" o.c. (14.4 W/ft ²)	3" o.c. (12 W/ft ²)	3.5" o.c. (10.3 W/ft ²)				
8	10	12	(1) 10 ft ²	81018089	120010WD-BKIT	1.0
13	15	18	(1) 15 ft ²	81018090	120015WD-BKIT	1.5
17	20	24	(1) 20 ft ²	81018091	120020WD-BKIT	2.0
21	25	30	(1) 25 ft ²	81018092	120025WD-BKIT	2.5
25	30	36	(1) 30 ft ²	81018093	120030WD-BKIT	3.0
29	35	42	(1) 35 ft ²	81018094	120035WD-BKIT	3.5
34	40	48	(1) 40 ft ²	81018095	120040WD-BKIT	4.0
38	45	54	(1) 45 ft ²	81018096	120045WD-BKIT	4.5
42	50	60	(1) 50 ft ²	81018097	120050WD-BKIT	5.0
51	60	72	(1) 60 ft ²	81018098	120060WD-BKIT	6.0
59	70	84	(1) 70 ft ²	81018099	120070WD-BKIT	7.0
67	80	96	(1) 80 ft ²	81018100	120080WD-BKIT	8.0
76	90	108	(1) 90 ft ²	81018101	120090WD-BKIT	9.0
84	100	120	(1) 100 ft ²	81008102	120100WD-BKIT	10.0
93	110	132	(1) 50 + (1) 60 ft ²	81018103	120110WD-BKIT	11.0
102	120	144	(2) 60 ft ²	81018104	120120WD-BKIT	12.0
110	130	156	(1) 60 + (1) 70 ft ²	81018105	120130WD-BKIT	13.0
118	140	168	(2) 70 ft ²	81018106	120140WD-BKIT	14.0
126	150	180	(1) 70 + (1) 80 ft ²	81018107	120150WD-BKIT	15.0

▲
Standard spacing

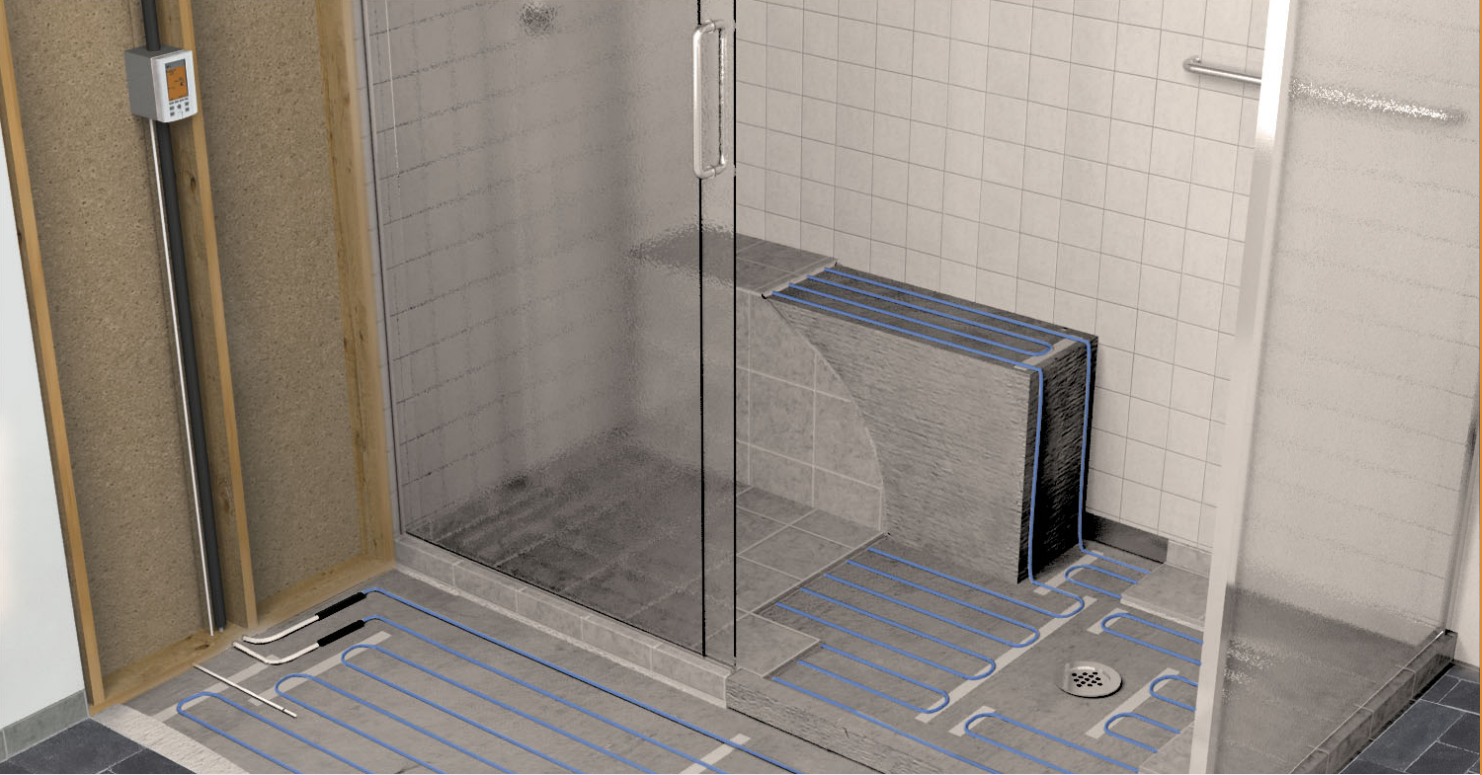

240 VAC WarmWire Kits

Coverage (ft ²)			Quantity & Size of Cables	Order#	Model#	Amps
2.5" o.c. (14.4 W/ft ²)	3" o.c. (12 W/ft ²)	3.5" o.c. (10.3 W/ft ²)				
84	100	120	(1) 100 ft ²	81018108	240100WD-BKIT	5.0
93	110	132	(1) 50 + (1) 60 ft ²	81018109	240110WD-BKIT	5.5
101	120	144	(1) 120 ft ²	81018110	240120WD-BKIT	6.0
110	130	156	(1) 60 + (1) 70 ft ²	81018111	240130WD-BKIT	6.5
118	140	168	(1) 140 ft ²	81018112	240140WD-BKIT	7.0
126	150	180	(1) 70 + (1) 80 ft ²	81018113	240150WD-BKIT	7.5
135	160	192	(1) 160 ft ²	81018114	240160WD-BKIT	8.0
143	170	204	(1) 80 + (1) 90 ft ²	81018115	240170WD-BKIT	8.5
152	180	216	(2) 90 ft ²	81018116	240180WD-BKIT	9.0
160	190	228	(1) 90 + (1) 100 ft ²	81018117	240190WD-BKIT	9.5
168	200	240	(2) 100 ft ²	81018118	240200WD-BKIT	10.0
185	220	264	(1) 100 + (1) 120 ft ²	81018119	240220WD-BKIT	11.0
202	240	288	(2) 120 ft ²	81018120	240240WD-BKIT	12.0
219	260	312	(1) 120 + (1) 140 ft ²	81018121	240260WD-BKIT	13.0
236	280	336	(2) 140 ft ²	81018122	240280WD-BKIT	14.0
253	300	360	(1) 140 + (1) 160 ft ²	81018123	240300WD-BKIT	15.0
270	320	384	(2) 160 ft ²	*81018124	240320WD-BKIT	16.0
286	340	408	(1) 160 + (1) 180 ft ²	*81018125	240340WD-BKIT	17.0
303	360	432	(3) 120 ft ²	*81018126	240360WD-BKIT	18.0
320	380	456	(2) 120 + (1) 140 ft ²	*81018127	240380WD-BKIT	19.0
337	400	480	(1) 120 + (2) 140 ft ²	*81018128	240400WD-BKIT	20.0
354	420	504	(3) 140 ft ²	*81018129	240420WD-BKIT	21.0
371	440	528	(2) 140 + (1) 160 ft ²	*81018130	240440WD-BKIT	22.0
388	460	552	(1) 140 + (2) 160 ft ²	*81018131	240460WD-BKIT	23.0
404	480	576	(4) 120 ft ²	*81018132	240480WD-BKIT	24.0
421	500	600	(3) 120 + (1) 140 ft ²	*81018133	240500WD-BKIT	25.0

Standard spacing



*WarmWire Kits larger than 300 ft² include a SunStat Relay II, as well as a SunStat Pro II thermostat. These sizes are not packaged in full color boxes.

The comfort of radiant without the mechanical room

- Offers enough capacity for space heating (verify heat loss calculation with our technical team)
- Installs over an existing slab in a "slab cap" or in a new slab
- Comfortable, even heat without the drying effects of forced air
- Does not promote circulation of pathogens or allergens
- Silent, maintenance-free heat with no vents or duct work
- Engineered to handle the rigors of any concrete installation
- Polyurethane outer jacket offers superior flexibility, abrasion and tear resistance

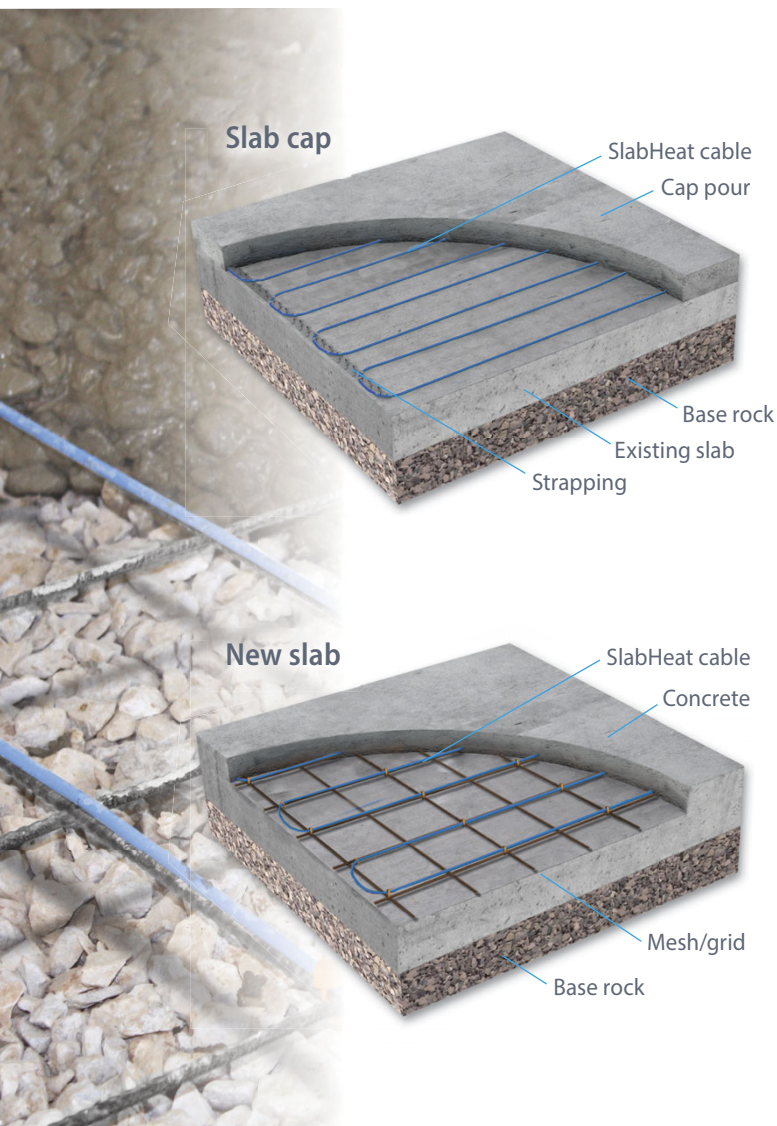

SlabHeat®

Regardless of the size, shape, or thickness of the concrete slab, SlabHeat is a simple way to provide the comfort of radiant heat. SlabHeat is engineered with the ability to produce enough BTU's to heat the slab, the space and the surface that people walk on.

120 VAC SlabHeat

Coverage (ft ²)		Length	Order#	Model#	Amps
4" o.c. (15 W/ft ²)	6" o.c. (10 W/ft ²)				
50	75	146'	81014956	SH15120050ST	6.3
66	98	193'	81014957	SH15120066ST	8.3
82	122	241'	81014958	SH15120082ST	10.3
100	149	294'	81014959	SH15120100ST	12.5
114	170	336'	81014960	SH15120114ST	14.3

▲
Standard spacing

240 VAC SlabHeat

Coverage (ft ²)		Length	Order#	Model#	Amps
4" o.c. (15 W/ft ²)	6" o.c. (10 W/ft ²)				
100	149	294'	81014961	SH15240100ST	6.3
132	196	388'	81014962	SH15240132ST	8.3
164	243	483'	81014963	SH15240164ST	10.3
200	297	590'	81014964	SH15240200ST	12.5
228	339	673'	81014965	SH15240228ST	14.3

▲
Standard spacing

Complete your system with a SunStat® thermostat



- Model options include energy saving schedules & touchscreens
- Can operate 120 or 240 VAC systems
- Built-in GFCI improves safety
- Air & floor temperature sensing
- Solutions for systems from 10 to 3000 ft²

SunStat Thermostats & Relays

Get all the features you need to provide warmth when & where you want it! Simply select one thermostat for every area requiring individual control. Add SunStat Relays for areas that need more than 15 Amps of power. SunStats can be used with any of the electric floor warming systems in this brochure.



	View	Pro II	Relay II	Dial
Control one zone of heating	●	●	-	●
Expand area controlled by SunStat View & Pro II thermostats	-	-	●	-
Dual voltage for operating 120 or 240 VAC floor heating systems	●	●	●	●
Built-in GFCI (5 milliamp trip) & 15 amp relay	●	●	●	●
15' floor sensor included	●	●	-	●
Floor & air temperature sensing	●	●	-	●
Touchscreen display	●	-	-	-
Adjustable brightness	●	-	-	-
Adjustment with buttons	-	●	-	-
Adjustment with dial	-	-	-	●
Indicator light	-	-	●	●
Display settings in English, French or Spanish	●	-	-	-
7-day schedule	●	●	-	-
Vacation override	●	●	-	-
Temporary hold setting	●	●	-	-
Automatic daylight savings time	●	●	-	-
SmartStart technology	●	●	-	-
Usage monitor	●	●	-	-
Adjustment lock to prevent setting changes	●	●	-	-
Compatible with 500810 Relay	●	●	-	-
Order#	81014974	81014979	81014982	81009187
Model#	500750-SB	500775-SB	500810-BB	500710-SC



LoudMouth™ Installation Monitor

The LoudMouth monitors electric heating wire elements during the entire installation process and sounds an alarm if the heating elements are cut or damaged. Features include 9-volt battery power, on/off switch, indicator lights, test button & audible alarm.

Order# 81007474 Model# 423250ST



TapeMat® Double-Sided Tape

36 yard length of extra double-sided tape

Order#81000051 Model#423275ST



CableStrap™

CableStrap makes it easy to install WarmWire® & SlabHeat® at the desired spacing. Each 25 ft roll covers approximately 40 to 50 ft² of heated floor area.

Order#81005523 Model#321301ST

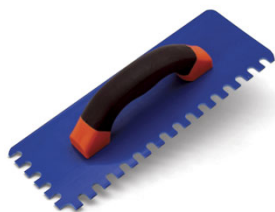

CableTrowel™

CableTrowel is recommended for applying mortar over any SunTouch® electric heating system. Consider using the 3/8" wide by 1/2" deep, U-shaped, notched CableTrowel for added peace of mind.

Order#81007407 Model#300400ST

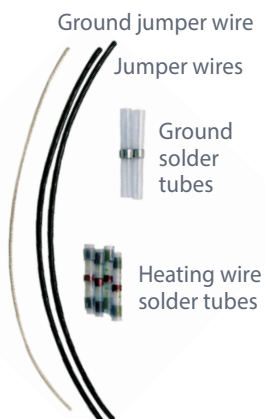

Heating Wire Repair Kit for Custom TapeMat®, TapeMat®, UnderFloor™ Mat & WarmWire®

Before ordering this kit consult with the factory to make sure it is suitable for the type of repair you are making. This kit is used for Custom TapeMat, TapeMat, UnderFloor Mat & WarmWire systems. Do not use it for ShowerMat, SlabHeat or ProMelt systems. Kit includes materials for one repair: 2 jumper wires, 1 ground jumper wire, 2 ground solder tubes, and 4 heating wire solder tubes. Detailed written instructions are included.

Order# 81007142 Model# 200299ST

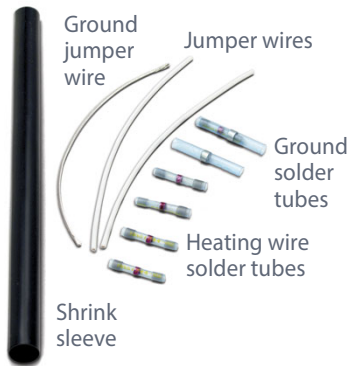

Heating Wire Repair Kit for SlabHeat®

Before ordering this kit consult with the factory to make sure it is suitable for the type of repair you are making. This kit is used for SlabHeat systems. Kit includes materials to make one repair: jumper wires, 1 ground jumper wire, 2 ground solder tubes, 4 heating wire solder tubes, and 1 shrink sleeve. Detailed written instructions are included.

Order# 81012263 Model# 200400



Extra Long Power Leads

Contact us to order products with power leads that are longer than the standard length. We'll attach a custom power lead to fit your application.

Custom TapeMat, TapeMat, ShowerMat, UnderFloor Mat & WarmWire

- Standard lead length is 10'
- 120 VAC or 240 VAC

SlabHeat

- Standard lead length is 20'
- 120 VAC or 240 VAC

Consult Factory to Order

SunTouch Snow Melting Products

SunTouch also offers a wide variety of snow melting products including the ProMelt® Mat, Cable, Controls, & Accessories. Please contact your SunTouch representative for more information.



ProMelt Mat



ProMelt Cable

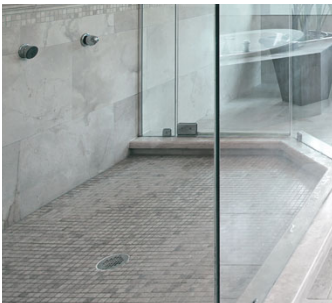

A Watts Water Technologies Company

USA: Tel: (888) 432-8932 • Fax: (417) 831-4067 • suntouch.com

Canada: Tel: (888) 208-8927 • Fax: (905) 332-7068

Latin America: Tel: (52) 81-1001-8600 • Fax: (52) 81-8000-7091