

# Manifolds

Watts Radiant offers a wide variety of stainless steel and copper manifolds. Any of these styles can be fitted with Onix, PEX Crimp, PEX Compression, RadiantPEX-AL Press, or RadiantPEX-AL Compression fittings.

## Stainless Steel Manifolds

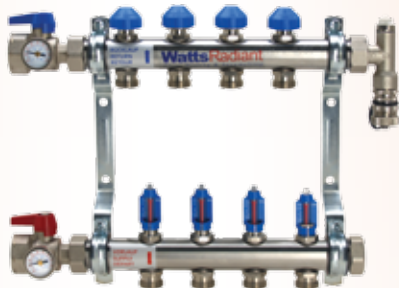

**Stainless Steel manifolds** are made of heavy-walled stainless steel. Matching fittings and accessories are made of solid brass and are heavily plated with nickel to match the appearance of the manifold trunk. Standard features included flow balancing valves, circuit isolation valves, and flow meters. Manifolds are sold in pre-mounted pairs in 1" and 1 1/2" sizes.

## Custom Tubular Manifold Pairs

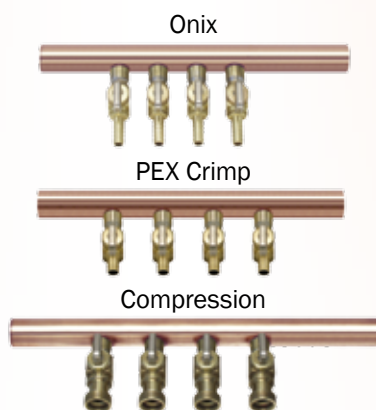

Watts Radiant **Custom Tubular manifolds** are manufactured to project specifications. All trunks are made of copper; all fittings and ball valves are brass. Every manifold is pressure tested before leaving the factory.

Custom Tubular are sold in pairs. Manifolds are available in 1"-6" ID trunk sizes.

Four configurations are possible:

- **Standard** — no mini ball valves
- **BVR** — mini ball valves on the return manifold
- **BVSR** — mini ball valves on supply and return manifolds
- **BBSR** — balance ball valves on return, mini-ball valves on supply manifold

## CustomCut™ Manifolds

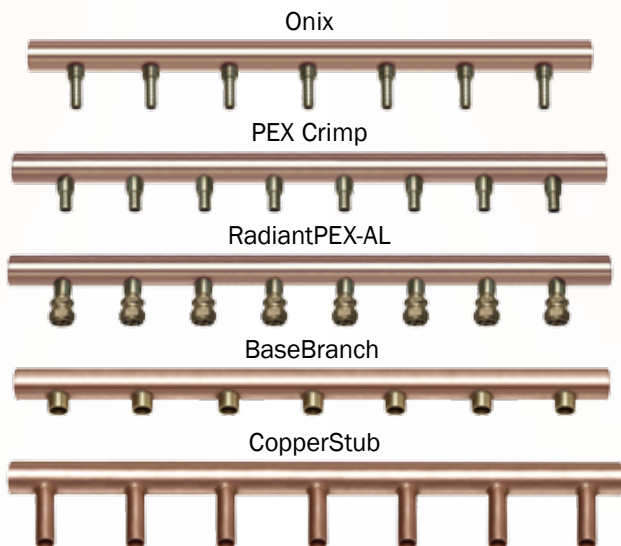

**CustomCut manifolds** are designed for flexibility for the installer. They come in 4 foot long copper sticks to be cut in the field. Sticks can be ordered with either 12 (4" spacing) or 16 (3" spacing) branches.

Sold Individually.

Five fitting styles are available for CustomCuts :

- **Onix**
- **PEX Crimp**
- **RadiantPEX-AL Press**
- **RadiantPEX-AL Compression**
- **T20** (for Onix, PEX, RadiantPEX-AL, and SST20 fittings)

## Swedged Manifolds

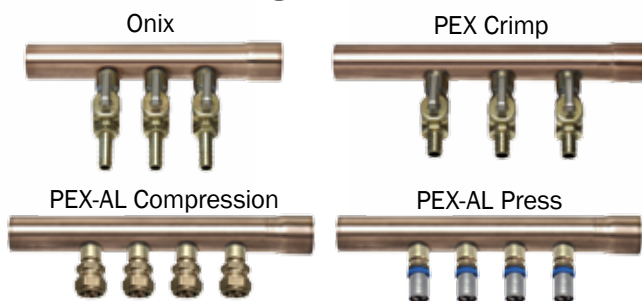

**Swedged manifolds** are 1" copper manifolds closed at one end and swedged at the other. Cut off the end of a 3-branch and solder it to another 3-branch to make a 6-branch manifold.

Sold Individually.

Swedged manifolds are available as Onix, PEX Crimp, or RadiantPEX-AL compression or press.

# Stainless Steel Manifolds

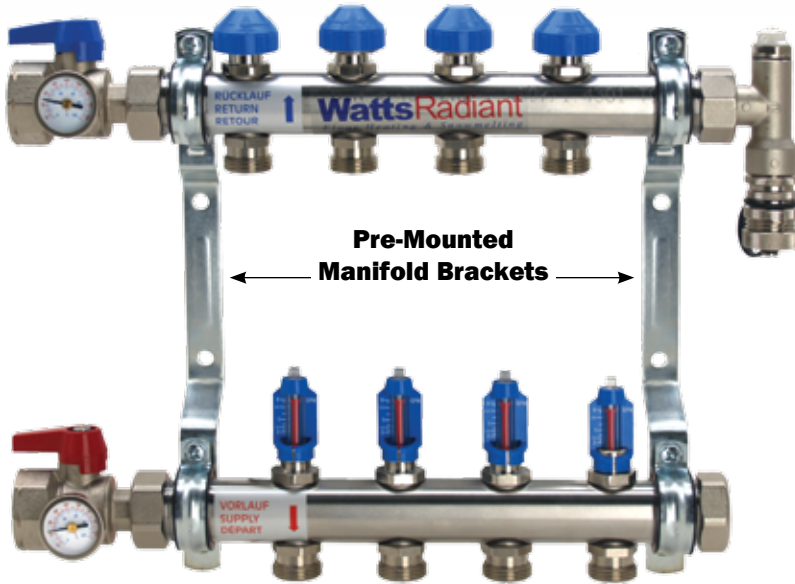

**Pre-Mounted  
Manifold Brackets**

Specifications	1"	1-1/2"
Trunk Material	ANSI 304 Stainless Steel	
Nominal Trunk Size	1"	1-1/2"
Circuit Spacing	2-1/8"	
Thread/Connection Type	BSP (British Standard Pipe)	
Max. Trunk Flow Rate	12 gpm	22 gpm
Max. Circuit Flow Rate	2 gpm	4 gpm
Max. Operating Temperature	167°F	
Max. Operating Pressure	87 psi	

## 1" and 1-1/2" Stainless Steel Manifolds

- Fast and Easy to Install
- Instant and Easy Circuit Balancing
- **NEW** vent/purge assembly allows even easier purging
- Professional Appearance
- **NEW** gaskets allow air or water pressure test.
- **NEW** flowmeter valves allow circuit isolation

Matching fittings and accessories are made of solid brass and heavily plated with nickel to match the appearance of the manifold trunk. Standard features include flow balancing valves and flow meters on each circuit. Manifolds are sold in pre-mounted pairs.

**Only SST20 styles are compatible with Stainless Steel manifolds.**

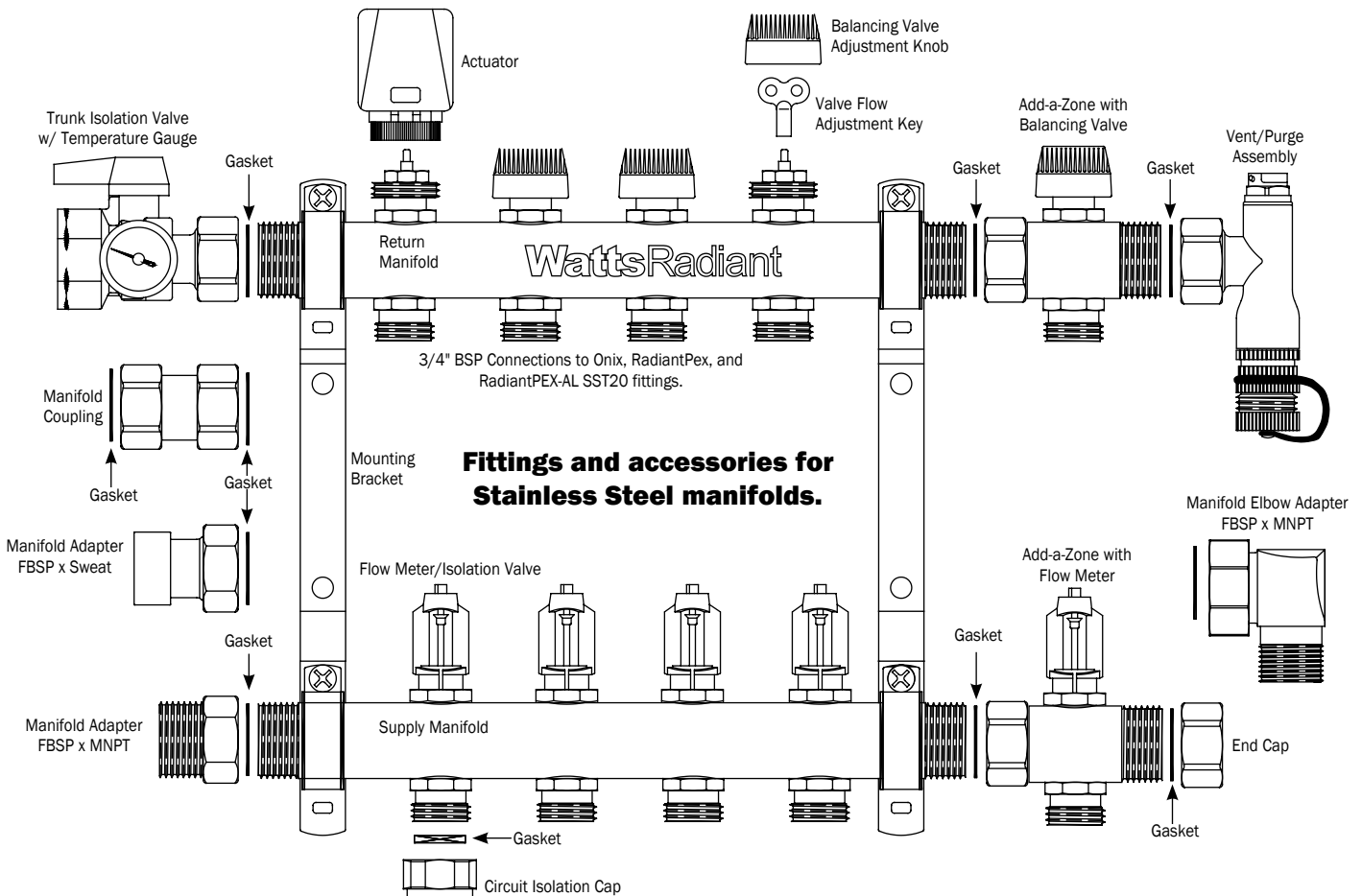

**Fittings and accessories for  
Stainless Steel manifolds.**

## Stainless Steel Manifolds



### 1" Flowmeter Manifolds, Stainless Steel with trunk isolation valve kit

1" Stainless Steel Manifold Kits	QTY	MODEL #	ORDER #	WT. (lbs)
1" Flowmeter Manifold, S.S., M-2 with Trunk iso. kit*	1 Kit	D3803002SS-KIT	81013279	11
1" Flowmeter Manifold, S.S., M-3 with Trunk iso. kit*	1 Kit	D3803003SS-KIT	81013280	12
1" Flowmeter Manifold, S.S., M-4 with Trunk iso. kit*	1 Kit	D3803004SS-KIT	81013281	13
1" Flowmeter Manifold, S.S., M-5 with Trunk iso. kit*	1 Kit	D3803005SS-KIT	81013282	14
1" Flowmeter Manifold, S.S., M-6 with Trunk iso. kit*	1 Kit	D3803006SS-KIT	81013283	16
1" Flowmeter Manifold, S.S., M-7 with Trunk iso. kit*	1 Kit	D3803007SS-KIT	81013284	16
1" Flowmeter Manifold, S.S., M-8 with Trunk iso. kit*	1 Kit	D3803008SS-KIT	81013285	17
1" Flowmeter Manifold, S.S., M-9 with Trunk iso. kit*	1 Kit	D3803009SS-KIT	81013286	18
1" Flowmeter Manifold, S.S., M-10 with Trunk iso. kit*	1 Kit	D3803010SS-KIT	81013287	19
1" Flowmeter Manifold, S.S., M-11 with Trunk iso. kit*	1 Kit	D3803011SS-KIT	81013288	20
1" Flowmeter Manifold, S.S., M-12 with Trunk iso. kit*	1 Kit	D3803012SS-KIT	81013289	22

\*with DK1000 Kit

### Flowmeter Manifolds only (no DK1000 kit)

1" Stainless Steel Manifolds	QTY	MODEL #	ORDER #	WT. (lbs)
1" Flowmeter Manifold, Stainless Steel, M-2	1 Pair	D3803002SS	81001981	9
1" Flowmeter Manifold, Stainless Steel, M-3	1 Pair	D3803003SS	81001982	10
1" Flowmeter Manifold, Stainless Steel, M-4	1 Pair	D3803004SS	81001983	11
1" Flowmeter Manifold, Stainless Steel, M-5	1 Pair	D3803005SS	81003398	12
1" Flowmeter Manifold, Stainless Steel, M-6	1 Pair	D3803006SS	81001984	13
1" Flowmeter Manifold, Stainless Steel, M-7	1 Pair	D3803007SS	81003682	13
1" Flowmeter Manifold, Stainless Steel, M-8	1 Pair	D3803008SS	81001985	14
1" Flowmeter Manifold, Stainless Steel, M-9	1 Pair	D3803009SS	81003687	15
1" Flowmeter Manifold, Stainless Steel, M-10	1 Pair	D3803010SS	81001986	16
1" Flowmeter Manifold, Stainless Steel, M-11	1 Pair	D3803011SS	81003688	17
1" Flowmeter Manifold, Stainless Steel, M-12	1 Pair	D3803012SS	81001987	19

1-1/2" Stainless Steel Manifolds	QTY	MODEL #	ORDER #	WT. (lbs)
1-1/2" Flowmeter Manifold, Stainless Steel, M-4	1 Pair	D3807604SS	81005355	13
1-1/2" Flowmeter Manifold, Stainless Steel, M-5	1 Pair	D3807605SS	81005356	14
1-1/2" Flowmeter Manifold, Stainless Steel, M-6	1 Pair	D3807606SS	81005357	15
1-1/2" Flowmeter Manifold, Stainless Steel, M-8	1 Pair	D3807608SS	81005358	17
1-1/2" Flowmeter Manifold, Stainless Steel, M-10	1 Pair	D3807610SS	81005359	19
1-1/2" Flowmeter Manifold, Stainless Steel, M-12	1 Pair	D3807612SS	81005360	21

Stainless Steel Manifolds are sold in pairs, mounted to metal bracket as shown. Accessories such as Trunk Isolation Ball Valves, Vent/Purge Assemblies, and Actuators are purchased separately. For added convenience, several of these accessories can be purchased in kits (see next page).

Each circuit can be individually balanced by adjusting the valve located under the blue cap. Maximum flow rates are 12 gpm for 1" manifolds and 22 gpm for 1-1/2" manifolds. Individual circuit flow meters are 0–2 gpm for 1" and 0–4 gpm for 1-1/2" manifolds.

Manifolds and gauges are rated to 167 °F at 87 psi pressure. Fittings are spaced at 2-1/8" on center. Order Onix, Crimp, or Compression fittings separately.

**Note:** Only SST20 styles are compatible with Stainless Steel manifolds.

## Stainless Steel Manifold Accessories



Add-a-Zone with Balancing Valve and Gasket



Add-a-Zone with Flow Meter and Gasket

**Stainless Steel Add-a-Zone** — add a branch to your manifold

DESCRIPTION	QTY	MODEL #	ORDER #	WT. (lbs)
Stainless Steel Add-A-Zone set, 1"	1	D3804000SS	81002934	3

**Add-a-Zones** make it easy to add additional capacity to a manifold already installed. Just thread them onto the end of a manifold. Set includes balance valve and flow meter sides of manifold.

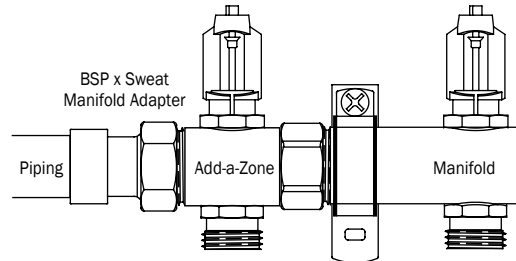

An Add-a-Zone attached to the end of a Stainless Steel supply manifold to increase capability.

## Simplify manifold ordering and save money with these Manifold Accessories Kits!

Manifold kits come complete with one Vent-and-Purge Assembly, one Manifold End Cap, and a pair of Trunk Isolation Valves, BSP x NPT Manifold Adapters, or BSP x Sweat Manifold Adapters.

**Note:** All Manifold Accessory Kits include both neoprene and fiber gaskets.

### Iso BV Kit



SS Manifold Accessories Kit with Trunk Isolation Ball Valves

### NPT Kit



SS Manifold Accessories Kit with BSP x NPT Manifold Adapters

### Sweat Kit



SS Manifold Accessories Kit with BSP x Sweat Manifold Adapters

DESCRIPTION	QTY	MODEL #	ORDER #	WT. (lbs.)
1" SS Accessories Kit w/ 1" FNPT Isolation Ball Valves	1 Kit	DK1000	81003736	3
1" SS Accessories Kit w/ 1" MNPT Manifold Adapters	1 Kit	DK2000	81003939	3
1" SS Accessories Kit w/ 3/4" Sweat Manifold Adapters	1 Kit	DK7000	81005455	3
1" SS Accessories Kit w/ 1" Sweat Manifold Adapters	1 Kit	DK3000	81005369	3
1-1/2" SS Accessories Kit w/ 1-1/2" FNPT Isolation Ball Valves	1 Kit	DK4000	81005370	3
1-1/2" SS Accessories Kit w/ 1-1/2" MNPT Manifold Adapters	1 Kit	DK5000	81005371	3
1-1/2" SS Accessories Kit w/ 1-1/2" Sweat Manifold Adapters	1 Kit	DK6000	81005372	3

**NOTE:** Only SST20 styles are compatible with Stainless Steel manifolds.

For Pricing, Please See Watts Radiant Price Guide.



## Stainless Steel Manifold Accessories

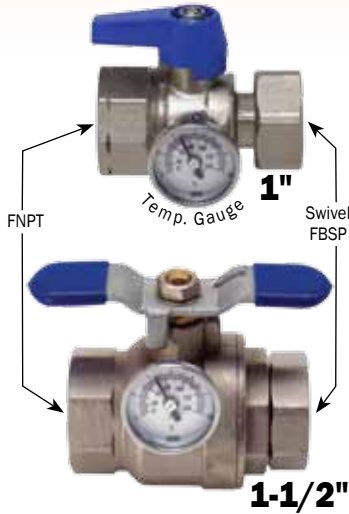

**Transitional Trunk Isolation Ball Valves with Temperature Gauge** — provides manifold isolation and transition to NPT threads.

DESCRIPTION	QTY	MODEL #	ORDER #	WT. (lbs)
1" SS Trunk Iso Valve, Red handle	1	D4201720-NR	81001995	2
1" SS Trunk Iso Valve, Blue handle	1	D4201720-NB	81001994	2
1-1/2" Trunk Iso Valve, Red handle	1	D3515930-NR	81005362	2
1-1/2" Trunk Iso Valve, Blue handle	1	D3515935-NB	81005363	2

These nickel-plated brass manifold ball valves include temperature gauges to measure supply and return temperatures for troubleshooting or system balancing. They also provide transition from MBSP manifold threads to FNPT threads.

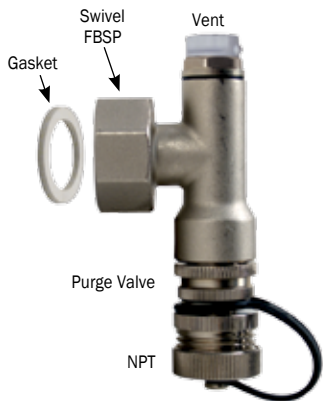

**Vent-and-Purge Assemblies** — for purging air and water from the zones.

DESCRIPTION	QTY	MODEL #	ORDER #	WT. (lbs)
Vent-and-Purge Assembly, 1"	1	D4201715-N	81001993	1
Vent-and-Purge Assembly, 1-1/2"	1	D3515940-N	81005457	1

The **Vent-and-Purge Assembly** allows purging of the zone at the manifold location. The Vent-and-Purge Assembly consists of a 1" BSP sleeve nut for attaching to the end of the manifold, and a 3/8" manual air vent valve. Also includes a 1/2" hose fitting with a built-in ball valve to allow zone draining and filling. Nickel-plated brass.



**Manifold End Caps** — to cap flow at end of manifold trunk.

DESCRIPTION	QTY	MODEL #	ORDER #	WT. (lbs)
SS Manifold End Cap, 1"	1	D063064-N	81001977	0.5
SS Manifold End Cap, 1-1/2"	1	D3515910-N	81005425	0.5

These **Manifold End Caps** are used to cap off the end of a Stainless Steel Manifold when a vent-and-purge assembly is not used. Nickel-plated brass.



**Stainless Steel Manifold Couplings** — for connecting one manifold to another.

DESCRIPTION	QTY	MODEL #	ORDER #	WT. (lbs)
SS Manifold Coupling, 1"	1	D402178-N	81001988	1
SS Manifold Coupling, 1-1/2"	1	D3290010-N	81005426	1

These **Manifold Couplings** are used to connect two manifold pairs. For example, an M-4 can be connected to an M-3 using the coupler to make an M-7. Nickel-plated brass for corrosion resistance. Sold individually.



**Transitional Swivel BSP x Female Sweat Manifold Adapters** — for connecting Stainless Steel Manifolds to copper pipe.

DESCRIPTION	QTY	MODEL #	ORDER #	WT. (lbs)
1" SS Manifold x 3/4" Female Sweat, Adapter	1	D0504	81005366	1
1" SS Manifold x 1" Female Sweat, Adapter	1	D0505	81005367	1
1-1/2" SS Manifold x 1-1/2" Female Sweat, Adapter	1	D0708	81005480	1

**BSP x Sweat Manifold Adapters** connect Stainless Steel Manifolds to or copper pipe. Nickel-plated brass for corrosion resistance. These are not needed if you are using the Transitional Trunk Valves. Sold individually.

**NOTE:** Only SST20 styles are compatible with Stainless Steel manifolds.

For Pricing, Please See Watts Radiant Price Guide.

# Stainless Steel Manifold Accessories

**Transitional BSP x NPT Manifold Adapters** – for connecting Stainless Steel manifolds to NPT fittings.



DESCRIPTION	QTY	MODEL #	ORDER #	WT. (lbs)
1" SS Manifold x 1" MNPT Adapter	1	D4201480	81001989	1
1-1/2" SS Manifold x 1-1/2" MNPT Adapter	1	D3515920	81005368	1

Use **BSP x NPT Manifold Adapters** to connect Stainless Steel Manifolds to standard pipe. This fitting features female BSP threads on the manifold side and male NPT threads on the pipe side. Nickel-plated brass for corrosion resistance. These are not needed if you are using the Transitional Trunk Isolation Valves.

**Transitional BSP x PEX Crimp Fitting Adapter** – for connecting PEX supply and return piping to Stainless Steel manifolds.



DESCRIPTION	QTY	MODEL #	ORDER #	WT. (lbs)
1" SS Manifold x 3/4" Crimp Adapter	1	D5SSX4C-N	81009351	1
1" SS Manifold x 1" Crimp Adapter	1	D5SSX5C-N	81009352	1
1-1/2" SS Manifold x 1" Crimp Adapter	1	D8SSX5C-N	81009353	1
1-1/2" SS Manifold x 1-1/4" Crimp Adapter	1	D8SSX7C-N	81009354	1

**NEW**



**Transitional BSP x PEX Crimp Fitting Elbow** – for connecting PEX supply and return piping to Stainless Steel manifolds.

DESCRIPTION	QTY	MODEL #	ORDER #	WT. (lbs)
1" SS Manifold x 3/4" Crimp Elbow	1	D5ESSX4C-N	81013300	1

**Transitional BSP x RadPEX-AL Fitting Adapter** – for connecting RadiantPEX-AL supply and return piping to Stainless Steel manifolds.



DESCRIPTION	QTY	MODEL #	ORDER #	WT. (lbs)
1" SS Manifold x 3/4" RadPEX-AL Press Adapter	1	D5SSX4RP-N	81009355	1
1" SS Manifold x 1" RadPEX-AL Press Adapter	1	D5SSX5RP-N	81009356	1
1-1/2" SS Manifold x 1" RadPEX-AL Press Adapter	1	D8SSX5PR-N	81009357	1

**Transitional BSP x Onix Fitting Adapters** – for connecting Onix supply and return piping to Stainless Steel manifolds.



DESCRIPTION	QTY	MODEL #	ORDER #	WT. (lbs)
1" SS Manifold x 3/4" Onix Adapter	1	D5SSX40-N	81009358	1
1" SS Manifold x 1" Onix Adapter	1	D5SSX50-N	81009359	1
1-1/2" SS Manifold x 1" Onix Adapter	1	D0711-N	81009360	1

**Transitional BSP x BSP Manifold Elbows** – easily install supply lines at 90° to manifold.



DESCRIPTION	QTY	MODEL #	ORDER #	WT. (lbs)
1" SS Manifold Elbow, Female BSP x Male BSP	1	D3517020-N	81005364	1
1-1/2" SS Manifold Elbow, Female BSP x Male BSP	1	D3515925-N	81005365	1

Use **Manifold Elbows** to connect directly to the manifold, then connect an ISO Ball Valve or other transitional fitting to the male BSP side of the Elbow. Adapter or a Trunk Isolation Ball Valve is used to transition to NPT threads.

## Stainless Steel Manifold Accessories

**Circuit Isolation Cap** — for unused circuits in Stainless Steel manifolds.

DESCRIPTION	QTY	MODEL #	ORDER #	WT. (lbs)
SS Circuit Isolation Cap	1	D4201700-S	81005479	1

**Circuit Isolation Caps** are used to “seal off” unused circuits on the manifolds. They can be used in conjunction with the built-in circuit isolation valves to convert an M-8 manifold into an M-7 manifold. Nickel-plated brass for corrosion resistance. Sold individually.

**SST20 Circuit Sweat Adapter** — for connecting 1/2" copper to stainless steel manifolds circuits.

DESCRIPTION	QTY	MODEL #	ORDER #	WT. (lbs)
1/2" Male Sweat x 3/4" SST20 Swivel Fitting	10	690101	81009452	1



**Valve Actuator** — for low wattage, individual radiant circuit control.

DESCRIPTION	QTY	MODEL #	ORDER #	WT. (lbs)
Valve Actuator	1	PZ656104	81001541	1

Great for multiple small radiant zones. The Valve Actuator provides on/off flow control to individual radiant circuits. Incorporates an indicator window that allows you to visually determine whether the valve is fully open or closed. Flow can be balanced prior to installing by turning the adjustment valve under the blue cap. Actuator is 24 VAC (2.5 W) with four wires to connect to the thermostat and close an end switch.

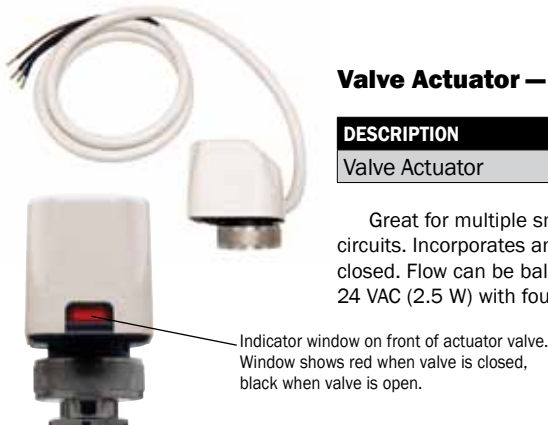

### Stainless Steel Manifold Replacement Parts

DESCRIPTION	QTY	MODEL #	ORDER #	WT. (lbs)
1" SS Manifold fiber replacement gasket	10	390095-10	81011084	1
1-1/2" SS Manifold fiber replacement gasket	10	390090-10	81011085	1
1" SS Manifold neoprene replacement gasket	10	390096-10	81011086	1
1-1/2" SS Manifold neoprene replacement gasket	10	390097-10	81011087	1
SS Manifold replacement blue cap	1	428337	81007329	1
1" SS Manifold replacement flowmeter/valve (0-2 gpm)	1	D3151122N	81011159	2
1-1/2" SS Manifold replacement flowmeter/valve (0-4 gpm)	1	D3151190N	81011160	2
SS Manifold replacement temperature gauge	1	D6151005	81003402	1



**Stainless Steel Manifold Pressure Test Kits** — specially fitted for Stainless Steel Manifolds.

DESCRIPTION	QTY	MODEL #	ORDER #	WT. (lbs)
1" Manifold Pressure Test Kit	1 Kit	D665161	81001996	4
1-1/2" Manifold Pressure Test Kit	1 Kit	D665261	81005373	4

**Manifold Pressure Test Kits** are available for rental. Call for prices.

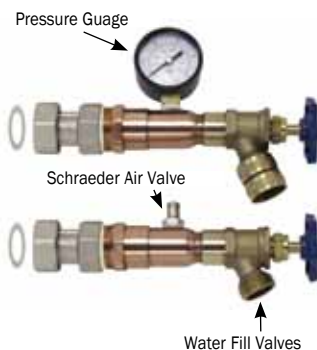

## Stainless Steel Manifold Accessories



**Manifold Boxes** — for wall or ceiling-mounted manifold systems.

DESCRIPTION	QTY	MODEL #	ORDER #	WT. (lbs)
Manifold Box, 16" x 29" x 4-1/2"	1	PZ162904	81001525	7
Manifold Box, 24" x 29" x 4-1/2"	1	PZ242904	81003497	15
Manifold Box, 40" x 29" x 4-1/2"	1	PZ402904	81004517	22

**Manifold Boxes** protect manifolds with a locking door. Made of powder-coated carbon steel. All types of 1" – 1-1/2" Watts Radiant manifolds can be mounted in these boxes. Dimensions are width x height x depth. Depth can be expanded to 6", and box height off floor is adjustable.



- 16" box fits a SS M-3 with vent/purge and iso valve
- 24" box fits a SS M-7 with vent/purge and iso valve
- 40" box fits a SS M-12 with vent/purge and iso valve

**See Zone HydroNex section for installed manifolds with pre-wired actuators.**

## Onix Fittings

3/4" Female SST20



**SST20 Onix Swivel Fittings** — for Stainless Steel, and Custom Tubular T20 Manifolds.

DESCRIPTION	QTY	MODEL #	ORDER #	WT. (lbs)
3/8" Onix x 3/4" BSP Swivel Fitting	10	689001-10	81000679	1
1/2" Onix x 3/4" BSP Swivel Fitting	10	689002-10	81000681	1
5/8" Onix x 3/4" BSP Swivel Fitting	10	689003-10	81000683	2
3/4" Onix x 3/4" BSP Swivel Fitting	10	689004-10	81000684	2

Use these female **Onix T20 Fittings** to connect Onix to our Stainless Steel, and Custom Tubular compression manifolds. Order Onix SelfTite or TorqueTite clamps separately.

**Note:** BSP threads are not compatible with NPT.

**SelfTite™ Clamps** — Pre-tensioned for easy field installation. The chrome-vanadium spring steel maintains a constant tension on the Onix under all operating conditions. SelfTites incorporate a zinc coating to guard against corrosion.



DESCRIPTION	QTY	MODEL #	ORDER #	WT. (lbs)
3/8" SelfTite Clamp (19 mm)	10	663019-10	81000523	3
3/8" SelfTite Clamp (19 mm)	50	663019-50	81000524	8
1/2" SelfTite Clamp (22 mm)	10	663022-10	81000526	4
1/2" SelfTite Clamp (22 mm)	50	663022-50	81000527	10
5/8" SelfTite Clamp (25 mm)	10	663025-10	81000529	4
5/8" SelfTite Clamp (25 mm)	50	663025-50	81000530	10
3/4" SelfTite Clamp (29 mm)	10	663029-10	81000532	5
3/4" SelfTite Clamp (29 mm)	50	663029-50	81000533	11

Use SqueezeTite™ Pliers to install SelfTite clamps (see Fasteners and Tools section for ordering information).

**TorqueTite™ Clamps** — our best stainless steel screw clamps.



DESCRIPTION	QTY	MODEL #	ORDER #	WT. (lbs)
3/8" TorqueTite Clamp (17–19 mm)	10	6641117-10	81002913	2
3/8" TorqueTite Clamp (17–19 mm)	50	6641117-50	81002914	6
1/2" TorqueTite Clamp (21–23 mm)	10	6641524-10	81002916	2
5/8" TorqueTite Clamp (25–27 mm)	10	6641928-10	81002919	2
3/4" TorqueTite Clamp (29–31 mm)	10	6642232-10	81002922	2

The Onix **TorqueTite** is a rugged, stainless steel clamp capable of withstanding large pressures and temperatures while being easy to install.



## PEX Swivel Crimp Fittings

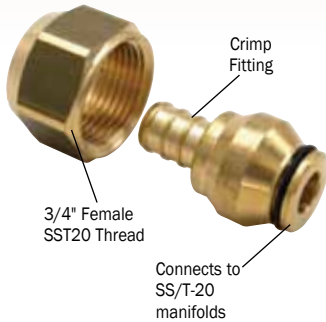

**SST20 Crimp Swivel Fittings** — for connecting PEX to Watts Radiant’s Stainless Steel and Custom Tubular T20 Compression manifolds.

DESCRIPTION	QTY	MODEL #	ORDER #	WT. (lbs)
3/8" Crimp x 3/4" SST20 Swivel BSP Fitting	10	PC690001-10	81005160	1
1/2" Crimp x 3/4" SST20 Swivel BSP Fitting	10	PC690002-10	81005162	1
5/8" Crimp x 3/4" SST20 Swivel BSP Fitting	10	PC690003-10	81005164	2
3/4" Crimp x 3/4" SST20 Swivel BSP Fitting	10	PC690004-10	81005395	2

Use these **SST20 Crimp Fittings** to connect PEX to our Stainless Steel or T20 Custom Tubular Manifolds. Order CrimpRings or CinchClamps separately.

NOTE: BSP Stands for British Standard Pipe (threads). These threads are not compatible with NPT (National Pipe Threads).

## PEX Crimp Fittings



**Copper CrimpRings** — for securing PEX to brass crimp fittings.

DESCRIPTION	QTY	MODEL #	ORDER #	WT. (lbs)
3/8" CrimpRing	100	PCCR2X-100	81001071	1
1/2" CrimpRing	100	PCCR3X-100	81001075	1
5/8" CrimpRing	100	PCCR6X-100	81004508	2
3/4" CrimpRing	100	PCCR4X-100	81001080	2

**Copper CrimpRings** are precision-formed, ductile copper connectors. When crimped, these connections form a simple, fast, and permanent seal between PEX and CrimpRing fittings. See RadiantPEX section for 1" and larger CrimpRings and fittings.

**Stainless Steel CinchClamps** — for fast, easy, one-tool connections.



DESCRIPTION	QTY	MODEL #	ORDER #	WT. (lbs)
3/8" CinchClamps	10	PCCC2X-10	81004993	1
3/8" CinchClamps	100	PCCC2X-100	81004994	1
1/2" CinchClamps	10	PCCC3X-10	81004995	1
1/2" CinchClamps	100	PCCC3X-100	81004996	1
5/8" CinchClamps	10	PCCC6X-10	81005114	2
5/8" CinchClamps	100	PCCC6X-100	81005115	3
3/4" CinchClamps	10	PCCC4X-10	81004997	2
3/4" CinchClamps	100	PCCC4X-100	81004998	3

**CinchClamps** have been proven in millions of connections. See RadiantPEX section for 1" CinchClamps and fittings.

## PEX Compression Fittings

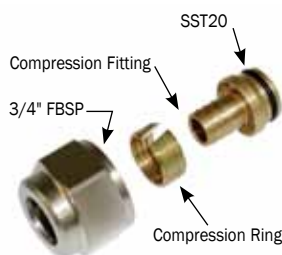

**SST20 PEX Compression Fittings** — for connecting PEX to Stainless Steel manifolds, and Custom Tubular T20 compression manifolds, or 3/4" male BSP x male sweat fittings.

DESCRIPTION	QTY	MODEL #	ORDER #	WT. (lbs)
3/8" PEX Compression x 3/4" SST20 Swivel BSP	10	PX690001-10	81005166	1
1/2" PEX Compression x 3/4" SST20 Swivel BSP	10	PX690002-10	81005168	1
5/8" PEX Compression x 3/4" SST20 Swivel BSP	10	PX690003-10	81005170	2
3/4" PEX Compression x 3/4" SST20 Swivel BSP	10	PX690004-10	81005172	2

## RadiantPEX-AL Press Fittings

3/4" Female SST20 Thread

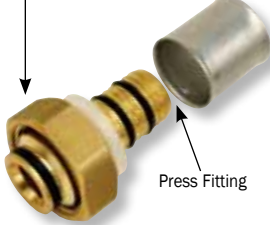
**SST20 RadiantPEX-AL Press Fitting** — for stainless steel and T20 manifolds.

DESCRIPTION	QTY	MODEL #	ORDER #	WT. (lbs)
1/2" Press x Adapter, 3/4" SST20 BSP	10	RLP0501B08T20-10	81010719	1
5/8" Press x Adapter, 3/4" SST20 BSP	10	RLP01B10T20-10	81008030	2

Press sleeves are included with all press fittings.

**Note:** BSP threads are not compatible with NPT.

## RadiantPEX-AL Compression Fittings

3/4" Female SST20 Thread

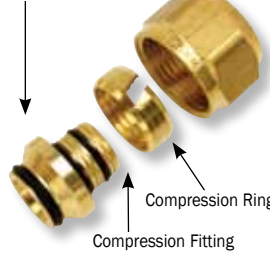

**RadiantPEX-AL SST20 Compression Fitting** — for stainless steel and T20 manifolds.

DESCRIPTION	QTY	MODEL #	ORDER #	WT. (lbs)
<b>NEW</b> 3/8" Compression x Adapter, 3/4" SST20 BSP	10	RLC01B06T20-10	81011138	1
1/2" Compression x Adapter, 3/4" SST20 BSP	10	RLC0501B08T20-10	81010735	1
5/8" Compression x Adapter, 3/4" SST20 BSP	10	RLC01B10T20-10	81008088	2
3/4" Compression x Adapter, 3/4" SST20 BSP	10	RLC01B12T20-10	81007735	2

Compression nut and ring included with all compression fittings.

**Note:** BSP threads are not compatible with NPT.

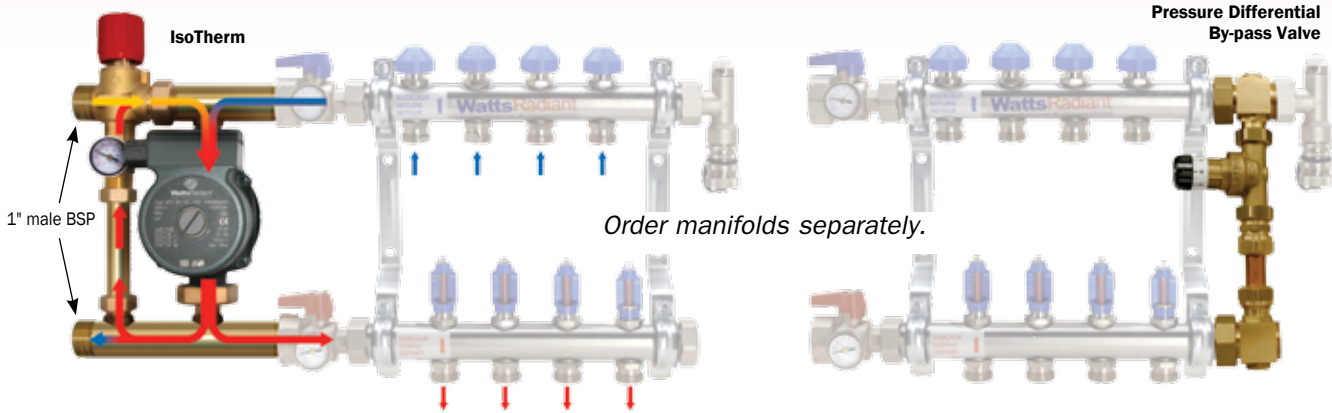
## Hydronic Accessories



**IsoTherm** — a pre-piped, pre-wired pump and mix valve for 1" Stainless Steel Manifolds.

DESCRIPTION	QTY	MODEL #	ORDER #	WT. (lbs)
IsoTherm	1	D3803995	81005361	15

Order isolation ball valves to help in purging air at start-up.

Order transitional fittings separately for transition to supply and return piping.

The **IsoTherm** is a compact, efficient pre-piped and pre-wired pump and mixing valve control designed to connect to Watts Radiant's 1" Stainless Steel Manifolds.

When combined with Watts Radiant's electrothermal actuators and actuator valve controls (not included), a complete trouble-free system is created, serving from 1 to 12 zones and delivering up to 50,000 BTU/h (maximum of 68,000 BTU/h with a minimum boiler temperature of 160°F).

The mixing valve has a standard temperature range of 113° to 140°F (45° to 60°C). The unit is factory set at 131°F (55°C). The valve is easily adjustable and locks in position with a "click-stop" device, preventing temperature drift.

A three-speed 1/25-HP pump comes pre-installed and pre-wired, taking the guesswork out of field installations. The Watts Radiant 1558 circulator will flow approximately 10 gpm at 10 ft. hd. This unit is ready — right out of the box!

Watts Radiant Circulator

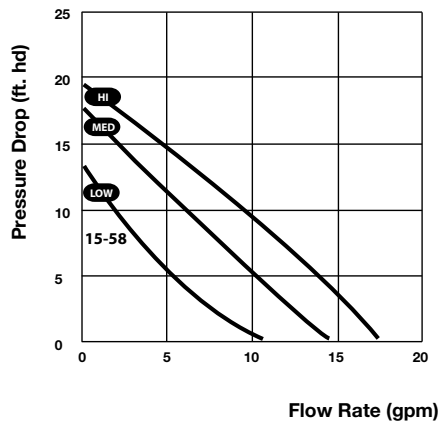

**Pressure Differential By-pass Valve** — for 1" Stainless Steel Manifolds.

DESCRIPTION	QTY	MODEL #	ORDER #	WT. (lbs)
Pressure Differential By-pass Valve	1	D4402050	81005345	5

Order manifold End Cap and/or Vent-and-Purge Assembly separately.

The **Pressure Differential By-pass Valve** for 1" Stainless Steel manifolds eliminates possible water velocity noise and water hammer. With this valve, pumps cannot exceed the actuator close-off pressure. Pump life increases because of minimal pressure surging as actuators open and close. Correct and constant flow is always ensured regardless of the number of actuators open.

This Pressure Differential By-pass Valve installs directly on the 1" Stainless Steel manifolds. This valve adjusts from 0.7 psi (1.6 feet water) to 10.3 psi (23.8 feet water) using a graduated knob. Water by-pass capacity is 1.2 gpm to 9 gpm. The knob is set and locked with a set screw to prevent tampering.

## Custom Copper Tubular Manifold Pairs

Custom Copper Tubular manifolds allow you to specify exactly what you want in a factory tested and warranted product.

All Custom Tubular manifolds are supply and return pairs.

Use the model number diagram below to order custom manifolds.

Several accessories can be installed on your Custom Tubular Manifolds, including:

- Brass O-ring Unions
- Full-port Brass Trunk Isolation Ball Valves
- Vent-and-Purge Assemblies

These must be treated as separate line items when ordering.

### How to order Custom Tubular manifolds

**XX 15 X X XX XXXX**

#### Balancing Options:

- Blank = no balancing
- BVR = Mini-ball valves on return manifold
- BVSR = Mini-ball valves on supply and return manifold
- BBSR** = Mini-ball valves on supply manifold, balance ball valves on return

#### Number of Circuits:

- 01 = 1 circuit
- 02 = 2 circuits
- 03 = 3 circuits
- etc... *Generally Watts Radiant recommends a maximum of 15 circuits per manifold for balancing reasons.*

#### Barb Size:

- 2 = 3/8"
- 3 = 1/2"
- 4 = 5/8"
- 5 = 3/4"

#### Manifold Trunk Size:

- 4 = 1" Copper Trunk
- 5 = 1 1/4" Copper Trunk
- 6 = 1 1/2" Copper Trunk
- 7 = 2" Copper Trunk
- \* call for larger trunk sizes

15 = Designator for Custom Manifolds

#### Manifold Type:

- Blank = Onix
- PC = PEX Crimp
- PX = T20 Universal (order fittings separately)
- RLP = RadiantPEX-AL Press (complete with Press sleeve)
- RLC = RadiantPEX-AL Compression (complete with compression nut and ring)

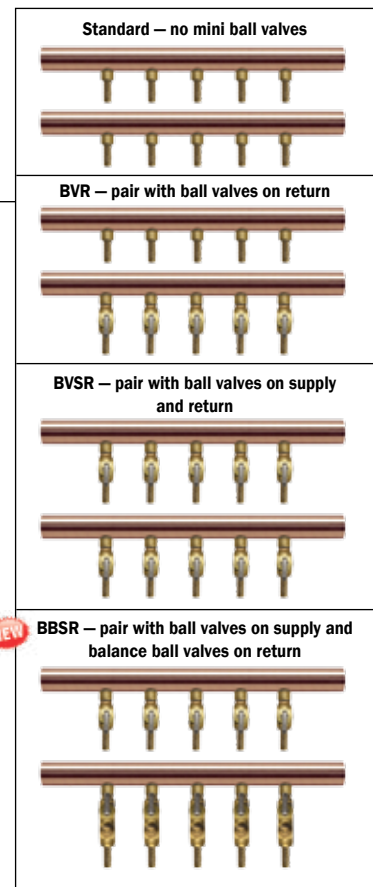
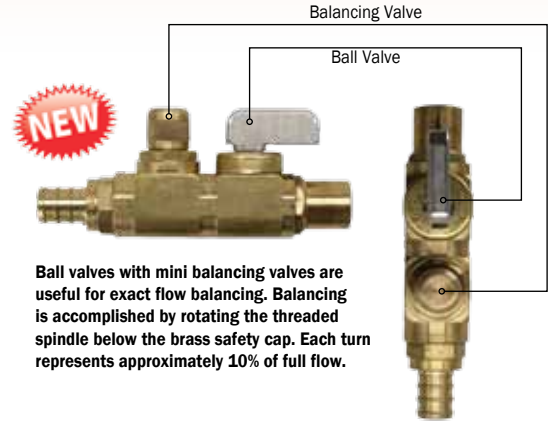

Watts Radiant makes large diameter tubular manifolds up to 6" ID. Other specialty items can be installed, such as zone valves, circuit setters, or full-port ball valves.

**Ordering examples:** •PC156410BVR= 10 branch, 1-1/2" trunk, 5/8" PEX Crimp manifold with mini ball valves on return  
•154207BBSR= 7 branch, 1" trunk, 3/8" Onix manifold with mini ball valves on supply and balance valves on return



## CustomCut™ Manifolds *\*COST EFFECTIVE\**

CustomCut Manifolds are designed for flexibility at the wholesale and the installation level. They come in 4-ft.-long copper “sticks” to be cut to length in the field – cut off five branches for a 5-branch manifold, seven branches for a 7-branch manifold, and so on. You can stock just a few types and have everything you need.

### CustomCuts are made in various styles:

- with Brass fittings: Onix, PEX, RadiantPEX-AL Press, RadiantPEX-AL Compression, and T20 Compression.
- with 1/2" and 3/4" Copper Stubs, for attaching standard ball valves or Female copper sweat fittings in the field.
- with 1/2" Brass Base Branches, for attaching Watts Radiant 1/2" male sweat fittings or Mini Ball Valves in the field.

CustomCuts are made with branches spaced at 3" (16 circuits) or 4" (12 circuits) on center, depending on the type of manifold. They are available with and without Mini Ball Valves (MBVs). Larger diameter trunks can be ordered as well.

CustomCuts are sold as a single manifold, not in pairs.

### Onix CustomCut Manifolds – 4 ft. long

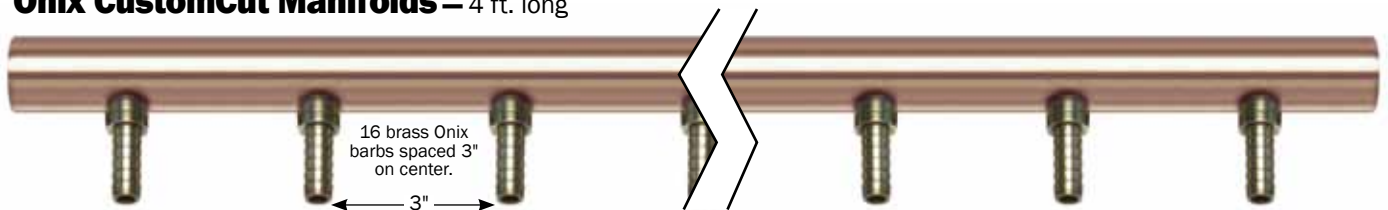

#### 16-branch CustomCut Manifolds, 3/8" Onix Barbs

DESCRIPTION	QTY	MODEL #	ORDER #	WT. (lbs)
3/8" Onix CustomCut, 16-branch, 1" Trunk (no MBVs)	1	204237	81001937	7
3/8" Onix CustomCut w/MBVs, 16-branch, 1" Trunk	1	204237BV	81001940	14

#### 16-branch CustomCut Manifolds, 1/2" Onix Barbs

DESCRIPTION	QTY	MODEL #	ORDER #	WT. (lbs)
1/2" Onix CustomCut, 16-branch, 1" Trunk (no MBVs)	1	204250	81001941	7
1/2" Onix CustomCut w/MBVs, 16-branch, 1" Trunk	1	204250BV	81001942	14

## CustomCut Manifolds

### PEX CustomCut Manifolds – 4 ft. long

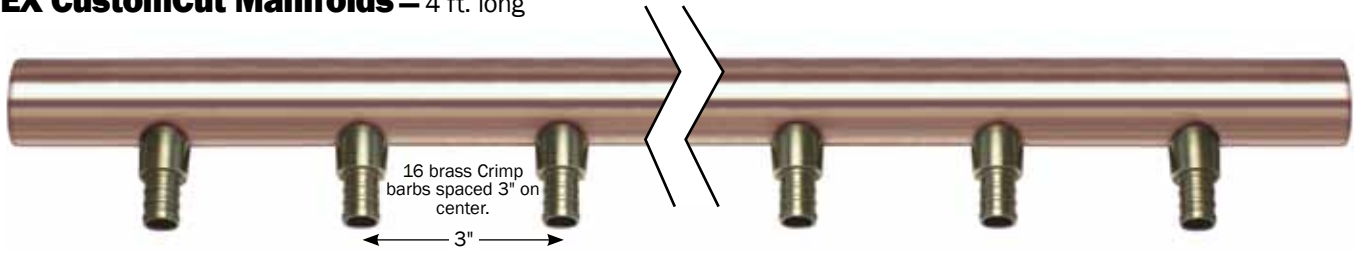

#### 16-branch CustomCut Manifolds, 3/8" PEX Crimp Barbs

DESCRIPTION	QTY	MODEL #	ORDER #	WT. (lbs)
3/8" Crimp CustomCut, 16-branch, 1" Trunk	1	PC204237	81001005	7
3/8" Crimp CustomCut w/MBVs, 16-branch, 1" Trunk	1	PC204237BV	81001006	14

#### 16-branch CustomCut Manifolds, 1/2" PEX Crimp Barbs

DESCRIPTION	QTY	MODEL #	ORDER #	WT. (lbs)
1/2" Crimp CustomCut, 16-branch, 1" Trunk	1	PC204250	81001007	7
1/2" Crimp CustomCut w/MBVs, 16-branch, 1" Trunk	1	PC204250BV	81001009	14

### T20 CustomCut Manifolds – for SST20 Swivel fittings, 4 ft. long **\*UNIVERSAL\***

T20 Manifolds are compatible with all SST20 (3/4" female BSP) fittings, including, SST20 Onix Swivel, SST20 Crimp Swivel, SST20 PEX Compression, SST20 RadiantPEX-AL Press, and SST20 RadiantPEX-AL Compression fittings. It's a universal, low-cost option. Order fittings separately.

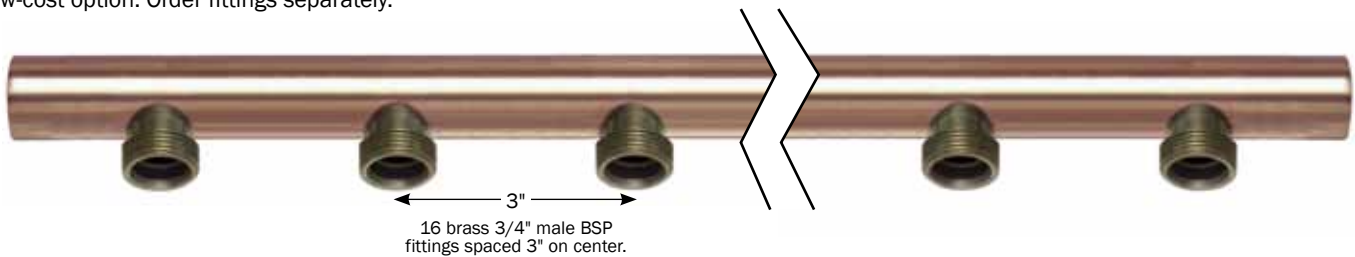

#### 16-branch CustomCut Manifolds, 3/4" Male BSP T20 fittings

DESCRIPTION	QTY	MODEL #	ORDER #	WT. (lbs)
3/4" BSP CustomCut, 16-branch, 1" Trunk	1	PX204275	81001481	7
3/4" BSP CustomCut w/MBVs, 16-branch, 1" Trunk	1	PX204275BV	81001483	14

## CustomCut Manifolds

### RadiantPEX-AL CustomCut Manifolds – Press Fittings, 4 ft. long

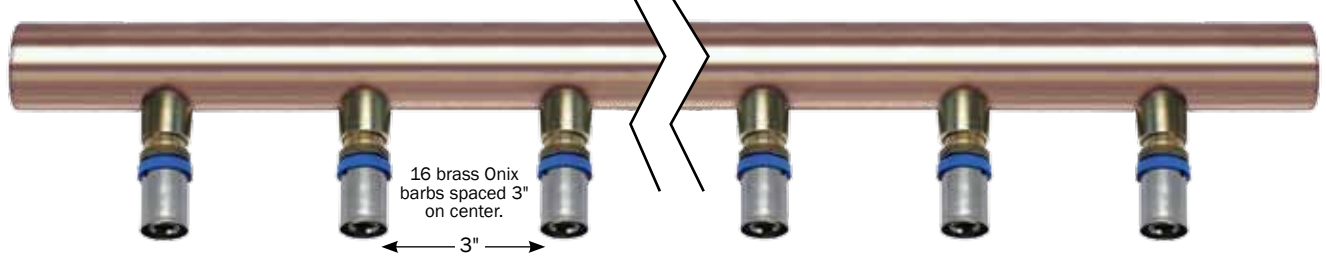

### 1/2" RadiantPEX-AL CustomCut Manifolds – Press Fittings

DESCRIPTION	QTY	MODEL #	ORDER #	WT. (lbs)
1/2" Press, 16- branch, 1" Trunk (no MBVs)	1	RLPM05-M16-08X16	81010693	7
1/2" Press w/MBVs, 16- branch, 1" Trunk	1	RLPM05-M16BV-08X16	81010690	14

All press manifolds are sold complete with press fittings including sleeve.

### RadiantPEX-AL CustomCut Manifolds – Compression Fittings, 4 ft. long

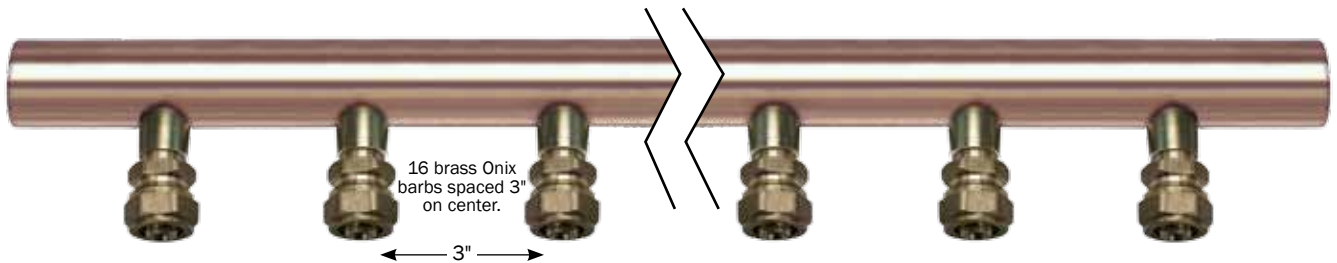

### 1/2" & 3/8" RadiantPEX-AL CustomCut Manifolds – Compression Fittings

DESCRIPTION	QTY	MODEL #	ORDER #	WT. (lbs)
<b>NEW</b> 3/8" Compression, 16- branch, 1" Trunk (no MBVs)	1	RLCM-M16-06X16	81011142	6
<b>NEW</b> 3/8" Compression w/MBVs, 16- branch, 1" Trunk	1	RLCM-M16BV-06X16	81011143	12
1/2" Compression, 16- branch, 1" Trunk (no MBVs)	1	RLCM05-M16-08X16	81010694	7
1/2" Compression w/MBVs, 16- branch, 1" Trunk	1	RLCM05-M16BV-08X16	81010692	14

All compression manifolds are sold complete with compression fittings including nut and compression ring.

## CustomCut Manifolds

### BaseBranch CustomCut Manifolds – 4 ft. long

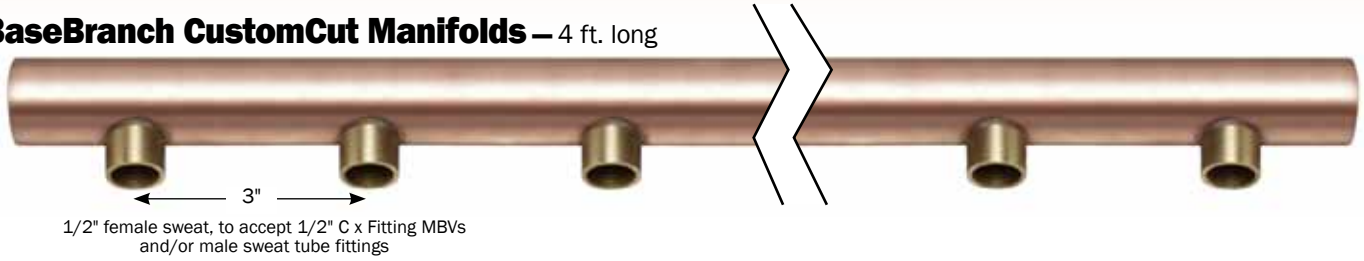

#### 16 – Branch CustomCut Manifolds, 1/2" BaseBranch (Female Sweat)

DESCRIPTION	QTY	MODEL #	ORDER #	WT. (lbs)
1/2" Brass BaseBranch, 16-branch x 1" Brass Trunk x 48" long	1	205250	81001947	7
1/2" Brass BaseBranch, 16-branch x 1-1/4" Copper Trunk x 48" long	1	205350	81002884	8

Sweat any 1/2" male sweat x barb adapters, whether Onix, Crimp, Press, or Compression. Many styles of tubing fittings fit these manifolds. For balancing, install Watts Radiant's Onix or PEX fitting ball valves.

### CopperStub CustomCut Manifolds

All stubs are brazed to the manifold trunk. CopperStub Manifolds are four feet long, with stubs spaced at 3" on center (16-branch) or 4" on center (12-branch). Ball valves, zone valves, female sweat fittings, or any other hydronic accessory can be installed directly onto the 1/2" or 3/4" stub.

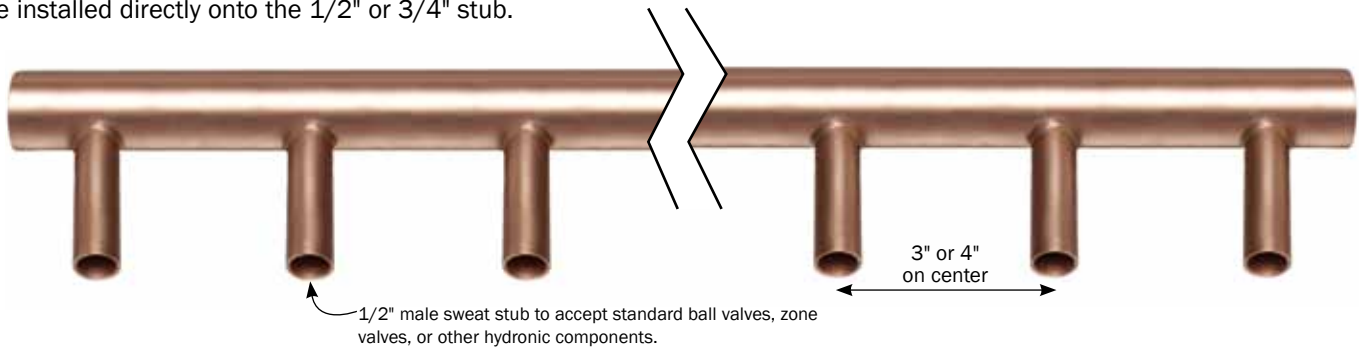

#### 1/2" CopperStub CustomCuts (Male Sweat)

DESCRIPTION	QTY	MODEL #	ORDER #	WT. (lbs)
1/2" Stub, 16-branch x 1" Trunk x 48" long	1	205116	81001944	7
1/2" Stub, 12-branch x 1" Trunk x 48" long	1	205112	81001943	6
1/2" Stub, 16-branch x 1-1/4" Trunk x 48" long	1	205216	81001946	8
1/2" Stub, 12-branch x 1-1/4" Trunk x 48" long	1	205212	81001945	7

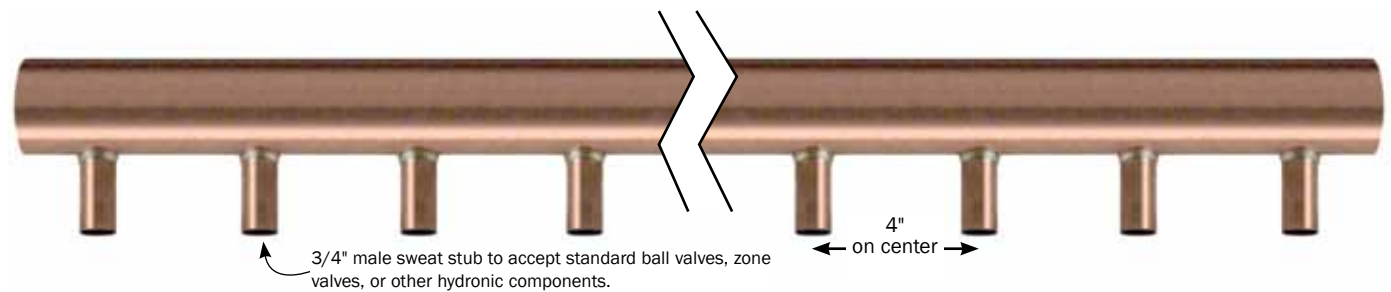

#### 3/4" CopperStub CustomCuts with 3/4" Stubs (Male Sweat)

DESCRIPTION	QTY	MODEL #	ORDER #	WT. (lbs)
3/4" Stub, 12-branch x 1-1/4" Trunk x 48" long	1	205412	81001951	7
3/4" Stub, 12-branch x 1-1/2" Trunk x 48" long	1	205512	81001953	8
3/4" Stub, 12-branch x 2" Trunk x 48" long	1	205612	81001955	9



## Swedged Manifolds with closed ends

Swedged Manifolds are easy to stock and easy to assemble. These 1" copper manifolds are closed at one end and swedged at the other. There is sufficient copper on the closed end to cut off and sweat to another manifold. Solder a 2-branch to a 3-branch to make a 5-branch, a 3-branch and 4-branch to make a 7-branch, etc. Four fitting styles are available: Onix, PEX Crimp, RadiantPEX-AL Press, and RadiantPEX-AL Compression. Swedged Manifolds are sold individually, with or without Mini Ball Valves (MBVs).

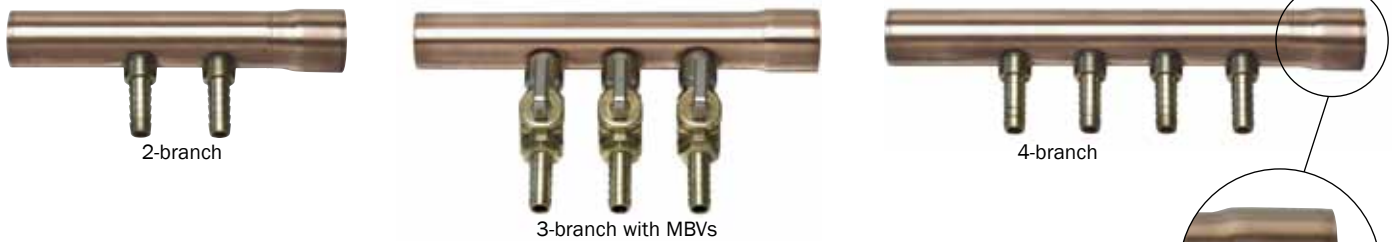

Onix Swedged Manifolds, 3/8" Onix fittings	QTY	MODEL #	ORDER #	WT. (lbs)
3/8" Onix Swedged, 2-branch	1	206222	81001956	2
3/8" Onix Swedged, 3-branch	1	206223	81001960	2
3/8" Onix Swedged, 4-branch	1	206224	81001964	2
3/8" Onix Swedged, 2-branch with MBVs	1	206222BV	81001959	2
3/8" Onix Swedged, 3-branch with MBVs	1	206223BV	81001963	2
3/8" Onix Swedged, 4-branch with MBVs	1	206224BV	81001967	3

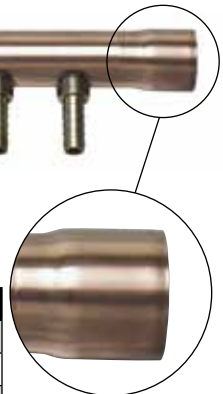

Manifold ends are swedged open to accept 1" pipe or another manifold.

PEX Crimp Swedged Manifolds, 1/2" Crimp fittings	QTY	MODEL #	ORDER #	WT. (lbs)
1/2" Crimp Swedged, 2-branch	1	PC206232	81001018	2
1/2" Crimp Swedged, 3-branch	1	PC206233	81001020	2
1/2" Crimp Swedged, 4-branch	1	PC206234	81001022	2
1/2" Crimp Swedged, 2-branch with MBVs	1	PC206232BV	81001019	2
1/2" Crimp Swedged, 3-branch with MBVs	1	PC206233BV	81001021	2
1/2" Crimp Swedged, 4-branch with MBVs	1	PC206234BV	81001024	3

RadiantPEX-AL Press Swedged Manifolds, 1/2" Press fittings.	QTY	MODEL #	ORDER #	WT. (lbs)
1/2" Press Swedged, 2-branch	1	RLPM05-M2-08X16	81010681	2
1/2" Press Swedged, 3-branch	1	RLPM05-M3-08X16	81010671	2
1/2" Press Swedged, 4-branch	1	RLPM05-M4-08X16	81010659	2
1/2" Press Swedged, 2-branch w/MBVs	1	RLPM05-M2BV-08X16	81010682	3
1/2" Press Swedged, 3-branch w/MBVs	1	RLPM05-M3BV-08X16	81010672	3
1/2" Press Swedged, 4-branch w/MBVs	1	RLPM05-M4BV-08X16	81010660	3

RadiantPEX-AL press manifolds are sold complete with press fittings including sleeve. These manifolds are only compatible with RadiantPEX-AL tubing.

RadiantPEX-AL Compression Swedged Manifolds, 3/8" Compression fittings	QTY	MODEL #	ORDER #	WT. (lbs)
3/8" Compression Swedged, 2-branch	1	RLCM-M2-06X16	81011144	3
3/8" Compression Swedged, 3-branch	1	RLCM-M3-06X16	81011145	3
3/8" Compression Swedged, 4-branch	1	RLCM-M4-06X16	81011146	3
3/8" Compression Swedged, 2-branch with MBVs	1	RLCM-M2BV-06X16	81011147	3
3/8" Compression Swedged, 3-branch with MBVs	1	RLCM-M3BV-06X16	81011148	3
3/8" Compression Swedged, 4-branch with MBVs	1	RLCM-M4BV-06X16	81011149	3

RadiantPEX-AL Compression Swedged Manifolds, 1/2" Compression fittings	QTY	MODEL #	ORDER #	WT. (lbs)
1/2" Compression Swedged, 2-branch	1	RLCM05-M2-08X16	81010684	2
1/2" Compression Swedged, 3-branch	1	RLCM05-M3-08X16	81010674	2
1/2" Compression Swedged, 4-branch	1	RLCM05-M4-08X16	81010662	2
1/2" Compression Swedged, 2-branch w/MBVs	1	RLCM05-M2BV-08X16	81010683	3
1/2" Compression Swedged, 3-branch w/MBVs	1	RLCM05-M3BV-08X16	81010673	3
1/2" Compression Swedged, 4-branch w/MBVs	1	RLCM05-M4BV-08X16	81010661	3

RadiantPEX-AL compression manifolds are sold complete with compression fittings including nut and compression ring. These manifolds are only compatible with RadiantPEX-AL tubing.

## Tubular Manifold Accessories — Factory-installed

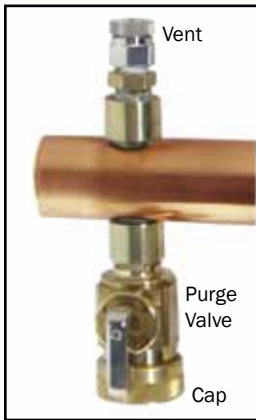

**Vent-and-Purge Assemblies** — factory-installed on Custom Tubular Manifolds.

DESCRIPTION	QTY	MODEL #	ORDER #	WT. (lbs)
1" Vent-and-Purge Assembly	1	160002	81000100	1
1-1/4" Vent-and-Purge Assembly	1	160003	81000101	1
1-1/2" Vent-and-Purge Assembly	1	160004	81000102	1
2" Vent-and-Purge Assembly	1	160005	81000103	1

**Vent-and-Purge Assemblies** allow water and air to be purged from the system at the manifold. The air vent is a "key-type" manual vent and the drain is threaded for a hose connection and comes complete with a shut-off ball valve and a cap. Available only for Custom Tubular Manifolds. Sold Individually.



**Full-port Trunk Isolation Ball Valves** — factory-installed on Custom Tubular Manifolds.

DESCRIPTION	QTY	MODEL #	ORDER #	WT. (lbs)
Trunk Isolation Ball Valve, 1"	1 pair	440101-03	81000344	1
Trunk Isolation Ball Valve, 1-1/4"	1 pair	440102-03	81003371	1
Trunk Isolation Ball Valve, 1-1/2"	1 pair	440103-03	81004854	2
Trunk Isolation Ball Valve, 2"	1 pair	440104-03	81003372	2

**Trunk Isolation Ball Valves** are installed to shut off the flow of water to the manifold. Sold in pairs.



**Unions (for Custom Tubular Manifolds)** — factory-installed on Custom Tubular Manifolds.

DESCRIPTION	QTY	MODEL #	ORDER #	WT. (lbs)
1" Installed Union	1 pair	464200	81000452	2
1-1/4" Installed Union	1 pair	464202	81000454	2
1-1/2" Installed Union	1 pair	464203	81000455	3
2" Installed Union	1 pair	464204	81000456	4

**Unions** allow manifolds to be easily pressure tested with our Pressure Test Kits. These all-brass unions feature heavy construction with EPDM o-rings to ensure leak-proof connections, even when hand-tightened. Sold in pairs.

## Tubular Manifold Accessories — Field-installed

**End Assemblies** — for CustomCut and Swedged Manifolds.

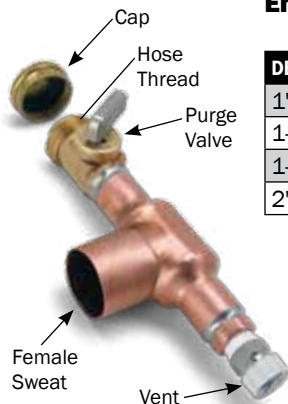

DESCRIPTION	QTY	MODEL #	ORDER #	WT. (lbs)
1" End Assembly	1	000102	81003193	1
1-1/4" End Assembly	1	000103	81003194	1
1-1/2" End Assembly	1	000104	81003195	1
2" End Assembly	1	000105	81003196	1

**End Assemblies** are intended for use with CustomCuts and Swedged Manifolds. They allow you to purge water and air from the system at the manifold location. The air vent is a "key-type" manual vent and the drain is threaded for a hose connection and comes complete with a shut-off ball valve and a cap. Sold Individually.

## Tubular Manifold Accessories



**Copper Tubular Manifold Pressure Test Kits** — pre-assembled to save time on the job site.

DESCRIPTION	QTY	MODEL #	ORDER #	WT. (lbs)
Manifold Pressure Test Kit 1"	1 kit	665161	81000550	3
Manifold Pressure Test Kit 1-1/4"	1 kit	665201	81000552	4
Manifold Pressure Test Kit 1-1/2"	1 kit	665241	81000553	5
Manifold Pressure Test Kit 2"	1 kit	665321	81000554	5

This two-part **Manifold Pressure Test Kit** enables you to test circuits and manifold connections with either air or water. They come standard with 1" brass unions to connect to Watts Radiant copper tubular manifolds or field-assembled manifolds. If you have manifolds without unions, please order loose Watts Radiant Unions to field connect with our Pressure Test Kits. Available for rental; call for prices.



**Manifold Boxes** — for wall or ceiling-mounted manifold systems.

DESCRIPTION	QTY	MODEL #	ORDER #	WT. (lbs)
Manifold Box, 16" x 29" x 4-1/2"	1	PZ162904	81001525	7
Manifold Box, 24" x 29" x 4-1/2"	1	PZ242904	81003497	15
Manifold Box, 40" x 29" x 4-1/2"	1	PZ402904	81004517	22

**Manifold Boxes** protect manifolds with a locking door. Made of powder-coated carbon steel. All types of 1" – 1-1/2" Watts Radiant manifolds can be mounted in these boxes. Dimensions are width x height x depth. Depth can be expanded to 6", and box height off floor is adjustable.

- 16" box fits a custom tubular M-5 (Onix)/M-4 (PEX or PAP) with vent/purge
- 24" box fits a custom tubular M-11 (Onix)/M-8 (PEX or PAP) with vent/purge
- 40" box fits a custom tubular M-20 (Onix)/M-16 (PEX or PAP) with vent/purge

**See Zone HydroNex section for installed manifolds with pre-wired actuators.**



**Universal Manifold Mounting Brackets** — for holding 1" to 2" Tubular Manifolds to wood frames.

DESCRIPTION	QTY	MODEL #	ORDER #	WT. (lbs)
Mtg. Brackets for 1"-1-1/4" Tubular Manifolds	1 Pr.	666162	81000558	1
Mtg. Brackets for 1-1/2"-2" Tubular Manifolds	1 Pr.	666163	81000559	1

**Manifold Mounting Brackets** are made of a flexible, high-temperature polymer that allows you to secure the manifold to a stud, joist, or other wood framing member.